

# Chemistry 2B Lab Manual

Standard Operating Procedures  
Winter Quarter 2019

Department of Chemistry  
University of California - Davis  
Davis, CA 95616

**Student Name** \_\_\_\_\_ **Locker #** \_\_\_\_\_

**Laboratory Information**

Teaching Assistant's Name \_\_\_\_\_  
Laboratory Section Number \_\_\_\_\_  
Laboratory Room Number \_\_\_\_\_  
Dispensary Room Number **1060 Sciences Lab Building**

**Location of Safety Equipment Nearest to Your Laboratory**

Safety Shower \_\_\_\_\_  
Eye Wash Fountain \_\_\_\_\_  
Fire Extinguisher \_\_\_\_\_  
Fire Alarm \_\_\_\_\_  
Safety Chemicals \_\_\_\_\_

# Preface

---

Chemistry is an experimental science. Thus, it is important that students of chemistry do experiments in the laboratory to more fully understand that the theories they study in lecture and in their textbook are developed from the critical evaluation of experimental data. The laboratory can also aid the student in the study of the science by clearly illustrating the principles and concepts involved. Finally, laboratory experimentation allows students the opportunity to develop techniques and other manipulative skills that students of science must master.

The faculty of the Chemistry Department at UC Davis clearly understands the importance of laboratory work in the study of chemistry. The Department is committed to this component of your education and hopes that you will take full advantage of this opportunity to explore the science of chemistry.

A unique aspect of this laboratory program is that a concerted effort has been made to use environmentally less toxic or non-toxic materials in these experiments. This was not only done to protect students but also to lessen the impact of this program upon the environment. This commitment to the environment has presented an enormous challenge, as many traditional experiments could not be used due to the negative impact of the chemicals involved. Some experiments are completely environmentally safe and in these the products can be disposed of by placing solids in the wastebasket and solutions down the drain with copious amounts of water. Others contain a very limited amount of hazardous waste and in these cases the waste must be collected in the proper container for treatment and disposal. The Department is committed to the further development of *environmentally safe experiments* which still clearly illustrate the important principles and techniques.

The sequence of experiments in this Laboratory Manual is designed to follow the lecture curriculum. However, instructors will sometimes vary the order of material covered in lecture and thus certain experiments may come before the concepts illustrated are covered in lecture or after the material has been covered. Some instructors strongly feel that the lecture should lead the laboratory while other instructors just as strongly believe that the laboratory experiments should lead the lecture, and still a third group feel that they should be done concurrently. While there is no “best” way, it is important that you carefully prepare for each experiment by reading the related text material before coming to the laboratory. In this way you can maximize the laboratory experience.

Questions are presented throughout each experiment. It is important that you try to answer each question as it appears in the manual, as it will help you understand the experiment as you do it. In addition, you are encouraged to complete the report as soon after laboratory as possible, as this is much more efficient than waiting until the night before it is due.

In conclusion, we view this manual as one of continual modification and improvement. Over the past few years, many improvements have come from student comments and criticisms. We encourage you to discuss ideas for improvements or suggestions for new experiments with your TA. Finally, we hope you find this laboratory manual helpful in your study of chemistry.



# Acknowledgments

---

This manual is the culmination of the efforts of many individuals.

Many faculty members have provided ideas for the creation of these laboratories and have made numerous suggestions regarding their implementation. Stockroom Dispensary Supervisors, both past and present, have had a role in helping to develop these experiments and, in particular, helping to ensure that the experiments are tailored to our laboratories here at UC Davis. Safety TAs, both past and present, have edited this manual to ensure that the experimental procedures are clear and current. In addition, many undergraduates have been involved in the development of experiments as part of undergraduate research projects.

# Table of Contents

Preface	i
Acknowledgments	iii
Introduction	vii
Experiments	
Thermochemistry	3
Colligative Properties	17
Chemical Equilibrium	29
Strong Acid - Strong Base Titration	39
Acid Dissociation Constants and the Titration of a Weak Acid	55
Polyprotic Systems	67
Acid-Base Buffers	79
Solubility Products	93
Procedures and Safety Handbook	
General Experimental Guidelines	A-5
1. Pre-Laboratory Preparation	
2. Data Collection	
3. Unknowns	
4. Writing A Laboratory Report	
Laboratory Work Grading Policies	A-7
Late Reports & Make-Up Policy	A-8
1. Late Reports	
2. Laboratory Make-Up Policy	
3. Laboratory Make-up Procedure	
4. Plagiarism and Unauthorized Collaboration	
Procedures for Online Pre- & Post-Laboratory	A-9
Accessing the Website	A-9
1. Viewing the Pre-laboratory Presentations.	
2. Taking the Pre-Lab Quiz	
3. Completing the Post-Laboratory Exercises.	
Scoring Scheme	A-15
Due Date/Late Submission of Post-lab Exercise	A-16
Chemistry Department Safety Policy	A-17

<b>Safety in the Chemistry 2 Laboratories</b>	<b>A-19</b>
<b>Safe Laboratory Practices</b> <b>A-19</b>	
1. Work Under Supervision	
2. Follow Instructions	
3. Safety Equipment	
4. Practice Good Housekeeping	
5. Avoid Chemical Contamination	
<b>Personal Protective Equipment (PPE)</b> <b>A-21</b>	
1. Dress Code	
2. Goggles	
3. Lab Coat	
4. Gloves	
<b>Maps and Emergency Evacuation Procedures</b>	<b>A-23</b>
1. Prior to Exiting	
2. Evacuation Routes/Exiting the Building	
3. Assembly Area	
<b>General Emergency Procedures</b>	<b>A-27</b>
1. Medical Emergency	
2. Major Incident	
3. Fire Alarm	
<b>Dispensary Procedures</b>	<b>A-28</b>
<b>Safety Data Sheet</b>	<b>A-29</b>
<b>Hazardous Chemicals</b>	<b>A-38</b>
Hazardous Chemicals <b>A-38</b>	
Hazardous Waste <b>A-39</b>	
<b>Statistical Treatment of Data</b>	<b>A-42</b>
1. Average and Standard Deviation	
2. Confidence Limits	
3. Relative Deviation	
4. Analysis of Poor Data: Q-test	
<b>An Introduction to Excel</b>	<b>A-45</b>
Excel Basics <b>A-46</b>	
Calculations in Excel <b>A-50</b>	
Graphing in Excel <b>A-53</b>	
<b>Common Laboratory Procedures</b>	<b>A-57</b>
<b>Handling Solids</b> <b>A-57</b>	
1. General Guidelines for Handling Solids	
2. Quantitative Transfer	
3. Using the Desiccator	

## Table of Contents

Handling Liquids	<b>A-59</b>	
1. Drawing Solutions from a Reagent Bottle		
2. Estimating Volume with a Dispo Pipet		
3. Transferring Liquid		
4. Capping a Flask with Parafilm		
5. Measuring Liquid Volumes		
Common Glassware in the Laboratory	<b>A-62</b>	
1. Care and Maintenance of Laboratory Glassware		
2. Beakers		
3. Erlenmeyer Flasks		
4. Graduated Cylinder		
5. Volumetric Flasks		
6. Burets		
7. Volumetric Pipet		
Using the Balance	<b>A-68</b>	
1. On/Off Switching		
2. Simple Weighing		
3. Taring		
4. Weighing by Difference		
Using the Centrifuge	<b>A-70</b>	
1. Procedure		
2. Safety Precautions		
Using the Hot Plate	<b>A-71</b>	
1. Features		
2. Safety Precautions		
Heating with a Bunsen Burner	<b>A-73</b>	
Filtration	<b>A-74</b>	
pH Meter Operating Instructions	<b>A-75</b>	
1. Preparing the pH meter		
2. Calibrating the pH meter		
3. Measure the pH of sample		
Fume Hood Use and Safety	<b>A-78</b>	
1. Features of the Fume Hood		
2. Before using the fume hood		
3. Guidelines for working with the fume hood		
4. Using the fume hoods in the Chemistry 2 Laboratories		
5. Fume Hood Emissions		
Locker Inventory		<b>A-81</b>
Start of Quarter Check-In	<b>A-81</b>	
End of Quarter Check-Out	<b>A-82</b>	



# Introduction

---

## Time Allocation and Grading

Below is an indication of the time allocation of each experiment. At the end of the quarter, the student's TA will sum the scores and give this to the instructor, who will modify it as described in the course syllabus.

<b>Title of Experiment</b>	<b>Lab Periods Allocated</b>
Thermochemistry	2
Colligative Properties	1
Chemical Equilibrium	1
Strong Acid-Strong Base Titration	1
Acid Dissociation Constants and the Titration of a Weak Acid	1
Polyprotic Systems	1
Acid/Base Buffers	1
Solubility Product	1
On-Line Prelab Quizzes (seven)	N/A
Lab Notebooks - Pre-lab (eight)	N/A

\* **On-Line Pre-laboratory Quizzes:** Each 2 point pre-lab quiz must be completed **at least 1 hour** prior to attending the student's scheduled lab class. All three quiz questions must be answered correctly before the student will be allowed to perform the laboratory experiment. If the quiz is failed on the first attempt, the student may take the quiz a second time. Because the questions are chosen randomly, different questions may be generated on the second attempt. Students who fail these quizzes are considered unprepared and unsafe to work in the laboratory and will not be allowed to begin the laboratory procedure until the TA is convinced the student is prepared. The TA will check the pre-laboratory write-up and quiz the student. The TA will allow entry into the laboratory only if the student answers the questions correctly and the pre-laboratory write-up is complete. This policy will be strictly enforced.

# Safety Policy

It is critical that you prepare for each experiment by reading it carefully before entering the laboratory. Not only will this ensure that you get the maximum benefit of the experience, but it also makes for a safer environment in the laboratory. This is important not only for your own safety but also for those around you. A number of policies have been developed in order to make sure that the laboratory is safe and that it runs smoothly.

In each experiment specific hazards are indicated by bold type and procedures are described that must be adhered to. Accidents commonly occur when the following rules, as approved by the Chemistry Department Safety Committee, are not followed.

## U.C. Davis Department of Chemistry Chem. 2 Series

### Standard Operating Procedures

#### SAFETY RULES FOR TEACHING LABORATORIES

The following rules are designed for your safety in the laboratory. The Laboratory Instructor (LI = TA, Laboratory Supervisor, and/or Course Instructor) is required to enforce these rules and has the full backing of the Department of Chemistry Staff and Faculty. The LI is also required to enforce all laboratory experiment-specific safety procedures in carrying out the laboratory work. Violations of these rules will result in expulsion from the laboratory.

1. **No one is allowed in the laboratory without the supervision of a LI. No laboratory work will be done without supervision. Perform only authorized experiments, and only in the manner instructed. DO NOT alter experimental procedures, except as instructed.**
2. **Specific permission from your LI is required before you may work in any laboratory section other than the one to which you have been assigned.** Only laboratory rooms where the same laboratory course is operating may be used for this purpose.
3. **If you have a special health condition (asthma, pregnancy, etc.) or any personal health concerns, consult your medical professional before taking chemistry lab.**
4. **If you come to the laboratory with non-compliant goggles, shoes, or clothing, you will not be allowed to work in the laboratory. In that context, note THERE ARE NO MAKE-UP LABORATORIES.** Your course grade will be significantly lowered or you may fail the course if you do not meet the lab attire requirements.
5. **100% cotton lab coats are REQUIRED.**
6. **Approved safety goggles must be worn by all persons at all times.** At NO TIME are safety glasses of any kind acceptable in the laboratory. Safety goggles may not be modified in any manner.

7. **Clothing that completely covers the legs—including the skin between the top of the shoe and the bottom of the pant leg—must be worn at all times in the laboratory** (tights or leggings are NOT suitable leg covering). Inadequate protection often leads to injury. Avoid wearing expensive clothing to lab as it may get damaged.
8. **Closed-toe, closed-heel shoes that completely cover the entire foot must be worn at all times.**
9. **Confine long hair while in the laboratory.**
10. **Horseplay and carelessness are not permitted and are cause for expulsion from the laboratory. You are responsible for everyone's safety.**
11. **Absolutely NO food or drinks are to be stored or consumed in the laboratory.** Contact lenses and cosmetics (hand lotion, lip balm, etc.) are not to be applied and medications are not to be consumed while in the laboratory.
12. Skateboards, rollerblades, and other such personal equipment must be stored outside of the laboratory. Personal electronics are only permitted when needed for the laboratory. Because cell phones or other personal electronic media can easily be damaged or contaminated in the laboratory, use of such devices is at the student's own risk.
13. **Learn the location and how to operate the nearest eyewash fountain, safety shower, fire extinguisher, and fire alarm box.** Basic first aid for any chemical splash is to wash the affected area for at least 15 minutes and seek medical attention. Use the emergency shower if appropriate, removing contaminated clothing for thorough washing. If the safety shower or eyewash is activated, the exposed person should be accompanied to the Student Health Center for further evaluation.
14. **Laboratory doors must remain closed except when individuals are actively entering or exiting the lab.**
15. **The student must have at least ONE UNGLOVED HAND when outside the laboratory.** Gloves are presumed to be contaminated and must not come into contact with anything outside the laboratory except chemical containers. Only use the **ungloved hand** to open doors, hold on to stair rails, or push elevator buttons.
16. **All activities in which toxic gases or vapors are used or produced must be carried out in the fume hood.**
17. **Mouth suction must never be used to fill pipets.**
18. **Containers of chemicals may not be taken out of the laboratory except to the dispensary for refill/replacement or to exchange full waste jugs for empty ones.** All containers must be **closed with the appropriate cap** before you take them into the hallway to the dispensary. Always use a bottle carrier when transporting chemicals and waste.
19. **Put all hazardous waste into the appropriate waste container(s) provided in your laboratory.** Do not overfill waste containers.

## **Introduction**

**20. All incidents, near misses, injuries, explosions, or fires must be reported at once to the LI.**

In case of serious injury or fire (even if the fire is out), the LI or Lab Supervisor must call 911. The student must always be accompanied to the Student Health Center.

**21. Keep your working area clean – immediately clean up ALL spills or broken glassware.**

**Dispose sharps in the appropriate container. Do not dispose pipette tips in regular trash.**

Clean off your lab workbench before leaving the laboratory.

**You must sign the Safety Acknowledgement sheet before you may work in the lab. If you have questions about these rules and procedures, please ask your LI before starting any laboratory work in this course.**

# Experiments



# Thermochemistry

## Introduction

---

Welcome to the Chemistry 2B Laboratory. During this first laboratory period you will go over the laboratory safety rules, become acquainted with the layout and equipment in the laboratory, and check-out the equipment in your locker. Then you will begin the first experiment of the quarter, which involves one of the most important areas of science, thermodynamics.

### Locker Check-in

Make sure your locker contains all of the proper equipment in the correct quantities. Please look in the Appendix of this manual for a locker list and drawings of common laboratory equipment. If you are missing any items, first check the box of extra glassware that is located at the back of the laboratory. If you still cannot find the missing equipment, visit the stockroom (SLB 1060). They will give you the glassware that you are missing. Please replace all missing equipment the first day of laboratory since the stockroom is only prepared to replace glassware during the first week. Place extra glassware in the box at the back of the room.

### Thermochemistry Experiment

This experiment is an introduction to the basic principles of thermochemistry and involves the exchange of energy as heat. The ideas and concepts involved in thermodynamics are illustrated in your everyday experiences. For example, on a hot summer day the hood of a car can get hotter than the sidewalk cement and when cooking, you have probably noticed that a wooden spoon does not heat as fast as metal one. After completing this experiment, you will better understand the reasons behind these and other thermal phenomena.

In the first part of this experiment you will construct a simple “coffee-cup” calorimeter. When used properly, this calorimeter can give very good results. In the next part of the experiment you will measure the specific heat of an unknown solid. Carefully follow the procedure outlined. In the third and fourth parts of the experiment, you will determine the enthalpies,  $\Delta H_{\text{rxn}}$ , of endothermic and exothermic reactions. You will be exploring the factors that cause a reaction to occur. In the fifth part of the experiment, you will design your own procedure to determine the heat of fusion,  $\Delta H_{\text{fus}}$ , of water.

In order to make sense of your observations for the third and fourth parts of the experiment you will need to consider an additional concept. In an exothermic reaction, the reaction releases heat, implying that the products are of lower energy than the reactants ( $\Delta H_{\text{rxn}}$  is negative). However, in an

### Safety First

---

After reviewing the safety rules with your TA, sign the back of the safety sheet and return it to your TA.

Remember to always follow the safety instructions when performing all experiments!

**Wear your goggles!**

endothermic reaction, heat is absorbed, indicating that the products are higher in energy ( $\Delta H_{\text{rxn}}$  is positive). What provides the driving force for an endothermic reaction?

The answer to this question is entropy, symbolized as  $S$ . Entropy will be fully discussed later in the course, but a brief introduction is provided here. Entropy can be thought of as a measure of the disorder or randomness in a system; the greater the disorder the higher the entropy. For instance, compare your lecture at the beginning of the hour and in the middle of the hour. At the beginning of the lecture everyone is coming into the room and milling around, finding seats and getting settled. Entropy is high. In the middle of the lecture everyone is seated in rows of chairs, all quietly facing the same direction with their attention focused in pretty much the same place. Entropy is low.

When entropy is discussed in chemistry, attention is focused on the number and motion of particles in a system. A reaction that results in an increase in the total moles of particles ( $n_f - n_i > 0$ ) is said to have an increase in entropy ( $\Delta S > 0$ ). Entropy also depends, in part, upon particle distribution in space and also on the distribution of energy (and motion) among the particles. The more freedom particles have to move around, the more entropy they will have. Changing a specific sample of a solid to a liquid does not increase the number of moles of the sample, but the energy and motion of the molecules does increase. Therefore, the entropy of the sample has increased. Changing the liquid to a gas dramatically increases the entropy of the system. Similarly, dissolving a salt in water will increase the entropy because the particles go from a very organized crystal to a less organized solution of free-moving ions.

Nature tends to minimize enthalpy ( $\Delta H$ ) and maximize entropy ( $\Delta S$ ). Entropy can therefore be a driving force for a reaction since greater entropy is a preferred condition. **Endothermic** reactions occur because entropy increases. The gain from increasing entropy ( $+\Delta S$ ) in these reactions is enough to counterbalance the unfavorable enthalpic conditions ( $+\Delta H$ ).

Increasing the entropy of a system has the same effect as minimizing the enthalpy of the system—it drives the reaction forward. You will look at reactions that vary in their enthalpic and entropic properties in the third and fourth parts of this experiment. You will see that one of the reactions is enthalpy-favored ( $-\Delta H$ ) but not entropy-favored ( $-\Delta S$ ), one is entropy-favored ( $+\Delta S$ ) but not enthalpy-favored ( $+\Delta H$ ), and one is favored by both enthalpy ( $-\Delta H$ ) and entropy ( $+\Delta S$ ).

Finally, in the last part of this experiment you will design your own procedure to determine the heat of fusion for ice,  $\Delta H_{\text{fus}}$ . Please note that you must come to the laboratory with an outline of the procedure you plan to use. **As preparation for this experiment, you should read the section on thermochemistry in your textbook.**



**Background: Heat, Specific Heat, Heat Capacity, and Molar Heat Capacity**

All parts of this experiment require the use of a calorimeter. In the first part of this experiment, you will construct an inexpensive but effective coffee-cup calorimeter. Before you can use this calorimeter to determine thermodynamic quantities you must determine the **heat capacity** of the calorimeter itself. You will do this by adding a weighed sample of hot water to a known amount of cold water in the calorimeter and measuring the temperature change.

The amount of energy required to change the temperature of an object or a sample of a substance by one degree Celsius or Kelvin is called that object's

**heat capacity:**  $C$  ( $J/^\circ C$ )

There are two variations on heat capacity that you also need to be familiar with:

**specific heat:**  $C_p$  ( $J/(g \cdot ^\circ C)$ )

and

**molar heat capacity:**  $J/(\text{mol } ^\circ C)$

The specific heat of a substance is the heat required to raise the temperature of **one gram** of the substance one degree, and the molar heat capacity is the amount of energy required to raise **one mole** of the substance by one degree. All substances have characteristic specific heats and molar heat capacities.

When two substances having different temperatures come into contact, energy in the form of heat is exchanged between them until they reach a common temperature. If they are insulated from their surroundings, the amount of heat lost from the hotter substance equals the heat gained by the colder one. The heat lost or gained is related to the mass, the specific heat of the substance, and the temperature change. This relationship is expressed as

$$q = m \times C_p \times \Delta T$$

where  $q$  is the heat,  $m$  is the mass,  $C_p$  is the specific heat of that substance, and  $\Delta T$  is the change in temperature. This equation can also be used if moles are substituted for mass, and molar heat capacity is substituted for specific heat. In this experiment, you will determine the heat capacity of your calorimeter.

When dealing with the calorimeter itself, you will combine the mass and specific heat of the calorimeter into a single term, the calorimeter's heat capacity. This can be done since the mass of the calorimeter does not change.

$$q = C_{\text{calorimeter}} \times \Delta T$$

## Procedure

---

**Work in pairs** on this experiment.

### Safety First

Wear gloves and use caution when handling acids and bases.

**Wear your goggles!**

### Stock Chemicals Used

Chemical	Maximum Amount Used
6M Hydrochloric Acid	< 15 mL
6M Sodium Hydroxide	< 15 mL
Ammonium Nitrate	< 5 g

### Part I. Determining the Heat Capacity of the Calorimeter

#### Safety First

Be careful when working with hot plate and boiling water. Always use beaker tongs to manipulate the beaker.

1. Set up a hot plate and heat 200–300 mL of deionized water to boiling in a 400 mL beaker. You may need to refresh your water supply periodically to prevent the water from boiling away completely.
2. Put two Styrofoam coffee cups in a 250 mL beaker. Take the top Styrofoam cup from the calorimeter, and tare it on the balance.

Weigh out about 70 grams of room temperature deionized water into the calorimeter and record the mass of the water to the nearest thousandth of a gram; this value is your mass of the cool water,  $mass^{\text{cool water}}$ .

3. Place the cup back into the calorimeter set-up. Take a 4" × 4" piece of cardboard, with the hole in the center, and place it on top of the coffee cups. Insert a thermometer through the hole.
4. Using the buret holder, gently clamp the thermometer and lower it into the cup so that the whole bulb is covered with water, but is not touching the bottom of the cup.

Avoid positioning the calorimeter too close to a hot plate so that the water inside the calorimeter remains cool.

5. Put 30 mL of room temperature deionized water in the 50 mL Erlenmeyer flask and record the mass of the water to the nearest thousandth of a gram in your notebook along with the corresponding flask label; this value is your mass of hot water,  $mass^{\text{hot water}}$ .

Repeat this process with your second 50 mL Erlenmeyer and set it aside for later.

6. Place one of the 50 mL Erlenmeyer flasks containing 30 mL of water into the beaker of boiling water using a utility clamp to hold it in place.

Make sure that the water level in the flask is below the water level in the 400 mL beaker. Allow the flask of water to sit in the boiling water

for 15 minutes in order for the temperature of water in the flask to equilibrate to about 100 °C.

7. After the 15 minutes, measure the temperature of the boiling water in the beaker with your second thermometer and record to the nearest 0.2°C; this temperature is your initial temperature of the hot water,  $T_i^{\text{hot water}}$ .
8. Just before transferring the hot water in the flask to the calorimeter, measure the temperature of the water in the calorimeter and record to the nearest 0.2°C; this temperature is your initial temperature of the cool water,  $T_i^{\text{cool water}}$ .

Next, remove the thermometer and cardboard top from the calorimeter. Using your clamp, grasp the flask containing the 30 mL of hot water near the top and quickly, but carefully, pour the hot water into the calorimeter. Be careful that no hot water on the outside of the Erlenmeyer flask drips into the calorimeter.

Once you have transferred the hot water to the calorimeter, you or your lab partner may begin repeating steps 6–7 with the second Erlenmeyer flask you prepared in step 5 to speed things up.

9. Replace the cardboard top on the calorimeter and insert the thermometer. Adjust the thermometer's height so that it is not touching the bottom or sides of the calorimeter, yet the water is covering the thermometer bulb.

Again, gently clamp the thermometer in the buret holder to keep the thermometer stationary.

10. Gently swirl the water in the calorimeter around the now stationary thermometer until the highest temperature is reached. This is the equilibrium temperature. Watch the thermometer closely as it rises.
11. To prevent temperature fluctuations, swirl the water in the calorimeter to evenly distribute the heat. Monitor the temperature and record the highest temperature attained to the nearest 0.2°C; this temperature is your final temperature,  $T_f$ .

12. While you are waiting for your second Erlenmeyer to reach about 100°C, repeat steps 2–4. Once the water in the flask has equilibrated, complete steps 8–10.

13. Repeat this whole procedure 1 more time, to finish with 3 total trials.

## Part II. Determining the Specific Heat of a Metal

Using the same calorimeter for which you determined the heat capacity, you will analyze an unknown metal sample to find its characteristic specific heat and identify the sample as lead, aluminum or copper.

1. Continue boiling 200–300 mL of deionized water in a 400 mL beaker using a hotplate. Again, you may need to refresh your water supply to prevent the water from boiling away completely.
2. Set up your calorimeter by placing the two Styrofoam cups in a 250 mL beaker as before. Take the top Styrofoam cup from the calorimeter, place it on the balance and tare it.

Weigh out about 70 grams of room temperature deionized water into the calorimeter and record the mass of the water to the nearest thousandth of a gram.

3. Place the cup back into the calorimeter set-up. Take your 4" × 4" piece of cardboard, with the hole in the center, and place it on top of the coffee cups. Insert a thermometer through the hole.
4. Using the buret holder, gently clamp the thermometer and lower it into the cup so that the whole bulb is covered with water but is not touching the bottom of the cup.
5. Obtain a sample of the unknown metal from the box at the front of the room. Identify the metal based on density and color and write down the type of metal you obtained in your laboratory manual.

The sample should be a piece of metal strung with nylon string. Do not remove the nylon string. Weigh the unknown metal sample using a tared weigh boat to protect it from contamination. Record the mass of the metal to the nearest thousandth of a gram.

6. Attach a utility clamp to the bench top rod and hang the metal's string from the clamp to submerge, but suspend, the metal in the 400 mL beaker of boiling water. Suspending the metal ensure it equilibrates with the temperature of the boiling water by preventing direct heating by hot plate (which will occur if the metal rests on the bottom of the beaker). Add more water to the beaker if necessary and return to a boil.
7. Suspend the metal in the boiling water for 3–4 minutes, to ensure the metal's temperature is approximately 100°C.
8. After the 3–4 minutes, measure the temperature of the boiling water in the beaker with your second thermometer and record to the nearest 0.2°C; this temperature is your initial temperature of the metal,  $T_i^{\text{metal}}$ .

### Safety First

To avoid burns, use crucible tongs to pick up hot metal. Never pick up a heated metal with your bare hands.

Be careful not to drop the metal into the beaker.

9. Just before transferring the metal to the calorimeter, measure the temperature of the water in the calorimeter and record to the nearest 0.2°C. This is the initial temperature of the water,  $T_i^{\text{water}}$ , and calorimeter,  $T_i^{\text{calorimeter}}$ .

Using the string, lift and shake the suspended metal vertically so that a maximum amount of hot water will drip off the metal surface. Quickly, but carefully drop the metal into the calorimeter and cover with the cardboard. Make sure that the metal sample is completely covered with water.

10. Replace the thermometer through the hole in the cardboard top on the calorimeter. Adjust the thermometer's height so that the water is covering the thermometer bulb without touching the metal or the Styrofoam cup.
11. Watch the thermometer rise until an equilibrium temperature (highest temperature) is reached. To prevent temperature fluctuations and evenly distribute the heat, try swirling the water in the calorimeter without breaking the thermometer on the metal.

Monitor the temperature and record the highest temperature attained to the nearest 0.2°C; this temperature is your final temperature,  $T_f$ .

12. Repeat this procedure two more times using the same metal sample, but replace the water in the calorimeter each time. You should have 3 total trials.

### Part III. Calculating the Enthalpy of an Endothermic Reaction

The cold packs in some first-aid kits are made of ammonium nitrate pellets encased in a plastic bag surrounded by water. When the cold pack is bent, the inner bag is broken and an endothermic reaction occurs as the ammonium nitrate dissolves in the water. As a result, the pack gets colder. You will be simulating this reaction in your calorimeter in order to calculate the enthalpy of reaction,  $\Delta H_{\text{rxn}}$ , in J/mol.

1. Set up your calorimeter by placing the two Styrofoam cups in a 250 mL beaker as before. Take the top Styrofoam cup from the calorimeter, tare it on the balance. Weigh out about 25 grams of room temperature deionized water into the calorimeter and record the mass of the water to the nearest thousandth of a gram.
2. Place the cup back into the calorimeter set-up. Take your 4" × 4" piece of cardboard, with the hole in the center, and place it on top of the coffee cups. Insert a thermometer through the hole.

- Using the buret holder, gently clamp the thermometer and lower it into the cup so that the whole bulb is covered with water, but is not touching the bottom of the cup.
- Tare a clean weigh boat and weigh out about 4–6 grams of ammonium nitrate. Record the mass of the ammonium nitrate to the nearest thousandth of a gram.
- Just before transferring the ammonium nitrate to the calorimeter, measure the temperature of the water in the calorimeter and record to the nearest 0.2°C. This is the initial temperature of the water,  $T_i^{\text{water}}$ , and calorimeter,  $T_i^{\text{calorimeter}}$ .

Next, remove the thermometer and cardboard top from the calorimeter. Carefully, add the ammonium nitrate to the calorimeter and cover with the cardboard. Make sure that none of the ammonium nitrate or water spills out of the calorimeter.

- Replace the thermometer through the hole in the cardboard on top of the calorimeter, and adjust its height so the bulb is covered without touching the bottom or sides of the calorimeter.
- Gently swirl the water in the calorimeter around the now stationary thermometer until the ammonium nitrate is dissolved and the solution achieves a uniform temperature throughout the calorimeter. Monitor the temperature and record the lowest temperature attained to the nearest 0.2°C; this temperature is your final temperature,  $T_f$ .
- Repeat this procedure two more times to finish with 3 total trials. Clean the calorimeter and thermometer between trials.

## Part IV. Calculating the Enthalpy of Exothermic Reactions

Neutralization reactions are exothermic reactions. You will be measuring quantities to estimate the enthalpy change for the neutralization of hydrochloric acid with sodium hydroxide. The number you will calculate is not, strictly speaking, the enthalpy of reaction of hydrochloric acid and sodium hydroxide. The heat released by diluting the acid and the base is also included in that number.

1. Solution preparation:
  - a. Prepare 60 mL of 2 M sodium hydroxide from 6.0 M sodium hydroxide stock solution.
  - b. Dispense no more than 25 mL of 6.0 M hydrochloric acid into a 100 mL beaker.
2. Calorimeter set-up:
  - a. Clean your Styrofoam cups and set up your calorimeter by placing the two Styrofoam cups in a 250 mL beaker as usual. Take your 4" × 4" piece of cardboard, with the hole in the center, and place it on top of the coffee cups. Insert a thermometer through the hole. Do not add water to your calorimeter.
  - b. Using the buret holder, gently clamp the thermometer and lower it into the cup so that the bulb is near but not touching the bottom of the cup.
3. Adding reagents to the calorimeter:
  - a. Transfer approximately 20 mL of 2 M sodium hydroxide solution you've prepared in a clean graduated cylinder. Record the volume to the nearest 0.2 mL.
  - b. Lift the cardboard top from the calorimeter and carefully transfer the sodium hydroxide from the graduated cylinder to the calorimeter.
  - c. Thoroughly clean your graduated cylinder and then carefully measure out about 8 mL of 6.0 M hydrochloric acid from your 100 mL beaker using a clean graduated cylinder. Record the volume to the nearest 0.2 mL.
  - d. Measure the temperature of the sodium hydroxide in the calorimeter and record to the nearest 0.2°C. This is the initial temperature of the water,  $T_i^{\text{water}}$ , and calorimeter,  $T_i^{\text{calorimeter}}$ .
  - e. Carefully, add the hydrochloric acid to the calorimeter and cover with the cardboard. Make sure that none of the sodium hydroxide or hydrochloric acid spills out of the calorimeter. Adjust the thermometer's height, if needed, so that it is not touching the bottom or sides of the calorimeter yet the solution is covering the thermometer bulb.

### Safety First

Do not put your hands or arms on the edges of the fume hood.

There may be spills of acids/chemicals which are not visible.

- f. Gently swirl the solution in the calorimeter to achieve a uniform temperature throughout the calorimeter. Monitor the temperature and record the highest temperature attained to the nearest 0.2°C; this temperature is your final temperature,  $T_f$ .
  - g. When your first trial is complete, pour the solution in your calorimeter into one 800 mL beaker. Save this solution.
4. Repeat the above procedure two more times to finish with 3 total trials.

### Green Chem

Don't throw away the styrofoam cups! Return them to your TA at the end of the lab.

#### Clean up:

- Slowly and carefully add 2 g of sodium bicarbonate to the 800 mL beaker containing all the used solutions from this part of the experiment.
- When the sodium bicarbonate is fully dissolved, pour this solution down the sink with copious amounts of water.

### Part V. Calculating the Heat of Fusion of Water

In this part of the experiment you will design an experiment to determine the heat of fusion of ice,  $\Delta H_{\text{fus}}$ . You will need your calorimeter, ice, water, and a balance. You may use any of the equipment in your locker. Be sure your method is repeatable. See how close you can come to the known result.

1. Design an experiment to determine the heat of fusion of ice. You should come to the laboratory with an outline of the procedure you plan to use.
2. Complete the experiment by performing three separate trials. Write down the detailed procedure you used.

#### Clean-Up:

- All solutions may be disposed of by washing down the sink with copious amounts of water. Be sure to rinse out the calorimeter before returning it at the front of the room.



## Data Analysis

---

### Part I

1. In step 8, why do you not want any of the water on the outside of the 50 mL Erlenmeyer flask to drip off into the calorimeter?
2. For each trial, calculate the heat lost by the hot water,  $q_{\text{hot water}}$ . Is this quantity positive or negative? The specific heat of water is  $4.184 \text{ J/g}\cdot^{\circ}\text{C}$ .
3. For each trial, calculate the heat gained by the cool water,  $q_{\text{cool water}}$ . Is this quantity positive or negative?
4. For each trial, calculate the heat gained by the calorimeter,  $q_{\text{calorimeter}}$ . This can be done by using the equation:  $-q_{\text{hot water}} = (q_{\text{cool water}} + q_{\text{calorimeter}})$ . Is  $q_{\text{calorimeter}}$  a positive or negative quantity? Hint: Be careful with your negative values here. Remember that  $(-q_{\text{hot water}})$  has the opposite algebraic sign value of  $(q_{\text{hot water}})$ .
5. For each trial, calculate the heat capacity of your calorimeter.

Hint: Write an expression for the heat capacity of the calorimeter in terms of  $q_{\text{calorimeter}}$  and the temperature change of the calorimeter. Note that the temperature change of the calorimeter is assumed to be the same as the temperature change of the “cool water” in the calorimeter.

6. Calculate the average heat capacity for the calorimeter.
7. Calculate a standard deviation for the average heat capacity.
8. Calculate a 90% confidence limit for this data.

### Part II

1. Why do we want the water to drip off the metal before it is placed in the calorimeter?
2. Calculate the specific heat for your metal for each trial. Remember that the heat lost by the metal is equal to the heat gained by the water in the calorimeter and by the calorimeter itself. This can be expressed as  $-q_{\text{metal}} = (q_{\text{water}} + q_{\text{calorimeter}})$ . The specific heat capacities are positive numbers.
3. Calculate the average specific heat for your metal sample.
4. Calculate the standard deviation of your average specific heat.
5. Using the physical properties of your metal, i.e. density & color, identify your metal.
6. Calculate the percent error of your average specific heat as compared to the accepted value.  $C_p(\text{Pb}) = 0.128 \text{ J/g}\cdot^{\circ}\text{C}$ ;  $C_p(\text{Al}) = 0.900 \text{ J/g}\cdot^{\circ}\text{C}$ ;  $C_p(\text{Cu}) = 0.387 \text{ J/g}\cdot^{\circ}\text{C}$

### Part III

1. Write a chemical equation that describes the dissolution of ammonium nitrate in water.
2. For each trial, calculate the number moles of ammonium nitrate dissolved.
3. For each trial, calculate the heat gained by the chemical system of ammonium nitrate,  $q_{\text{rxn}}$ . This can be done by using the equation:  $q_{\text{rxn}} = -(q_{\text{water}} + q_{\text{calorimeter}})$ . The calorimeter and the water are losing heat. Therefore,  $q_{\text{water}}$  and  $q_{\text{calorimeter}}$  are negative values.
4. The heat transfer in the calorimeter is taking place at constant pressure. Therefore, we can equate the heat gained by the chemical system of ammonium nitrate,  $q_{\text{rxn}}$ , to its enthalpy of reaction,  $\Delta H_{\text{rxn}}$ . For each trial, calculate the enthalpy of the reaction per mole of ammonium nitrate in units of Joules per mole.
5. Calculate the average enthalpy of reaction for the dissolution of ammonium nitrate in J/mol.
6. Calculate the standard deviation of the enthalpy of reaction.
7. Is the dissolution reaction of ammonium nitrate enthalpy-favored? Explain your answer.

### Part IV

1. Write the chemical equation for the neutralization reaction of hydrochloric acid and sodium hydroxide.
2. Calculate the number moles of hydrochloric acid used in the reaction for each trial.
3. In order to calculate the heat gained by water,  $q_{\text{water}}$ , the mass of calorimeter must be determined. Calculate the mass of water using the combined volume of 6.0 M hydrochloric acid with 6.0 M sodium hydroxide and the density of water, 1.00 g/mL.
4. For each trial, calculate the heat lost by the chemical system,  $q_{\text{rxn}}$ . This can be done by using the equation:  $q_{\text{rxn}} = -(q_{\text{water}} + q_{\text{calorimeter}})$ .
5. The heat transfer in the calorimeter is taking place at constant pressure. Therefore, we can equate the heat lost by the chemical system,  $q_{\text{rxn}}$ , to its enthalpy of reaction,  $\Delta H_{\text{rxn}}$ . For each trial, calculate the enthalpy of the neutralization reaction per mole of hydrochloric acid in units of Joules per mole.
6. Calculate the average enthalpy of reaction for the neutralization in J/mol.
7. Calculate the standard deviation of the enthalpy of reaction.
8. Is the neutralization reaction enthalpy favored? Explain your answer.

### Part V

1. For each trial, calculate the heat lost by the water in the calorimeter,  $q_{\text{water}}$ .
2. For each trial, calculate the heat lost by the calorimeter,  $q_{\text{calorimeter}}$ .

3. The heat gained by the ice resulted in the ice melting,  $q_{ice}$ , and raised the temperature of the melted ice from  $0^{\circ}\text{C}$  to the final temperature of the water in the calorimeter,  $q_{ice-water}$ . For each trial, calculate the heat of fusion per gram of ice.
4. Calculate the average heat of fusion per gram of ice.
5. Calculate the standard deviation for the average.
6. Calculate your percent error. The accepted value for the Heat of Fusion of ice, according to the textbook, is  $330\text{ J/g}$ . Note that this value is reported here only to 2 significant figures.

**Conclusion.**

Compose a paragraph summary of this experiment. Include some comments about the sources of error in the experiment that may be responsible for the difference between the values you have obtained and the accepted literature values for the properties you studied in this experiment. Discuss the reasons for your measured value of the specific heat of the metal being too high or too low.



# Colligative Properties

## Introduction

---

**Colligative properties** are the properties of a solution that depend on the amount of a chemical species in solution, and not on the identity of the species in solution. Examples of these properties include boiling point elevation, freezing point depression, and osmotic pressure.

### Freezing Point Depression

In this experiment, you will study the second of these common examples using deionized water as a solvent. You may recall from your textbook that freezing point depression is described by the equation:

$$\Delta T_f = i \times K_f \times m$$

where  $\Delta T_f$  is the freezing point depression,  $i$  is a value known as the van't Hoff factor,  $K_f$  is the freezing point constant of the solvent, and  $m$  is the molality of the solution. The freezing point depression,  $\Delta T_f$ , is the difference between the freezing point of the pure solvent and the freezing point of the solution. A solution of NaCl has a van't Hoff factor of  $i=2$ , a solution of  $\text{MgCl}_2$  has a van't Hoff factor of  $i=3$ , and a solution of a non-dissociating substance like sugar has a van't Hoff factor of  $i=1$ .

## Cooling Curve

A **cooling curve** is a plot of temperature versus cooling time, constructed to analyze phase change. In this experiment, the cooling curve will be used to discover the freezing point of a solution.

In theory, a solution's temperature will fall until it reaches its freezing point, where it will experience a phase change before falling further. However, it is often possible for *supercooling* to occur, where the solution remains in the liquid phase while its temperature drops below its freezing point. Below is a cooling curve graph **without** the supercooling effect.

Cooling Curve without Supercooling Effect

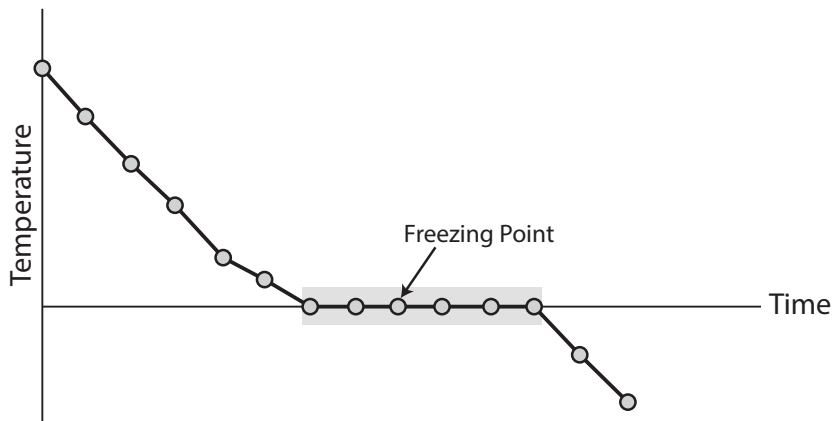

When the system is perturbed by the introduction of a small crystal, an outside perturbation of the system, or continued cooling, the supercooled liquid may suddenly convert to a solid while its temperature rises to its freezing point. Below is a cooling curve graph showing the supercooling effect.

Cooling Curve with Supercooling Effect

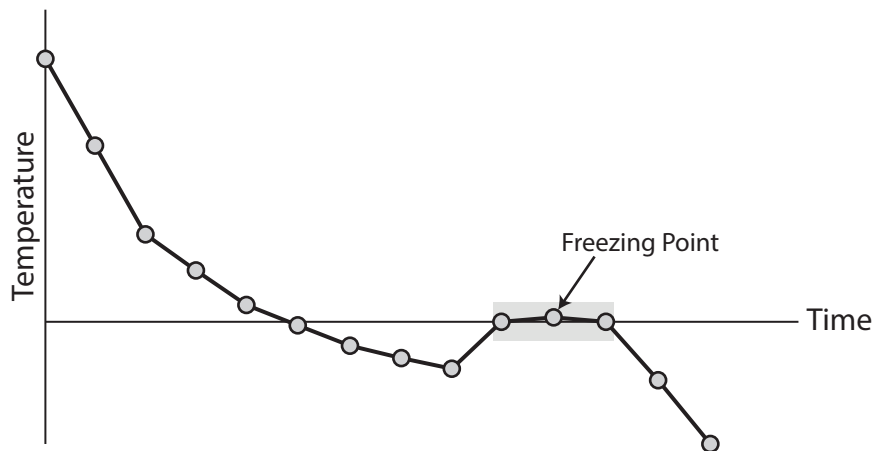

### Experiment Overview

During this experiment, you will first measure the normal freezing point of water in your experimental apparatus. This will require the use of a cooling bath prepared from salt, ice, and water. In the second part of the experiment you will measure the freezing point of a solution of water with sodium chloride as a solute, in order to determine the freezing point depression constant for water. Finally, you will use the  $K_f$  that you have determined in Part II to find the molecular mass of an unknown.

### Learning Goals

The following is a list of concepts and techniques applicable to this experiment. As you are working in the lab, pay attention to how they are related to each procedure and the experiment as a whole.

### Concept and Theory

Ensure that you understand the following before lab:

- Colligative properties. (Zumdahl chapter 17.5–17.7)
- Molality.

The following is a list of concepts and techniques applicable to this experiment. As you are working in the lab, pay attention to how they are related to each procedure and the experiment as a whole.

### Lab Techniques

Learn and practice the following during lab:

- Use of volumetric pipets.
- Preparation and use of an ice/salt mixture cooling bath.
- Determination of freezing point with a cooling curve.

## Procedure

---

### Safety First

Wear your goggles and gloves throughout this experiment.

**Work in pairs** on this experiment.

Each student must collect data and submit a separate report. The actual data analyses and the written reports must be done entirely independently of your lab partner or other students. Make sure that you avoid unauthorized collaboration and plagiarism. All suspected violations of the Code of Academic Conduct will be referred to Student Judicial Affairs.

### Stock Chemicals Used

Chemical	Maximum Amount Used
Sodium chloride	0.5–0.6 g
Unknowns A, B, C	Follow Label Instructions A: 1 g B: 2 g C: 3 g

### Part I. Determining the Freezing Point of Water

- Check out a LabQuest, a Go!Temp temperature probe, and a freezing point apparatus from your TA.
- Prepare the **cooling bath** with an 800 mL beaker.
  - Using a 400 mL beaker, transfer 300 mL of ice to the 800 mL beaker.
  - Acquire approximately 100 mL of rock salt into a 150 mL beaker. Add half of the rock salt into the 800 mL beaker.
  - Add to the cooling bath another 300 mL of ice and the rest of the rock salt.
  - Add 100 mL of DI water to the chilled 400 mL beaker. Rinse the wall of the beaker and pour the cooled water into the ice bath.
  - Using a glass stir rod, gently stir the mixture to ensure thorough mixing.
  - Place the 800 mL beaker in the Styrofoam box provided.

### Green Chemistry

It is extremely important that you conserve ice in this experiment.

Never use more ice than instructed. Always reuse ice when possible.



3. Prepare the **freezing point apparatus**.
  - a. Using a 10 mL volumetric pipet, accurately transfer 10.00 mL of DI water into the freezing point apparatus.
  - b. Set up the apparatus as shown below. Assemble the test tube of the apparatus with the cap, thermometer, and stirrer.

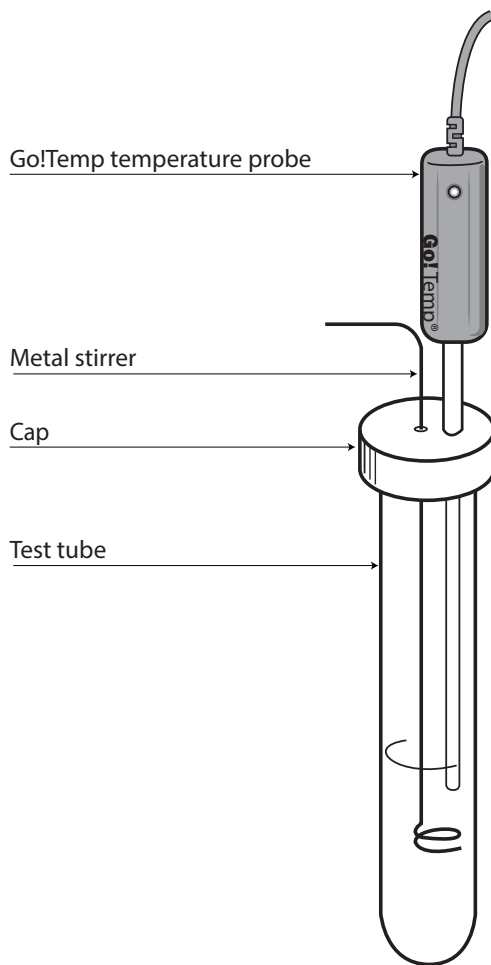

Figure 1. Freezing point apparatus with Go!Temp temperature probe.

4. Set up the LabQuest.
  - a. Connect the Go!Temp temperature probe to the LabQuest.
  - b. Turn on the LabQuest.
  - c. Browse to the **Sensors** (📡) tab, tap **Sensors** at the top, and select **Data Collection...** from the drop-down menu.

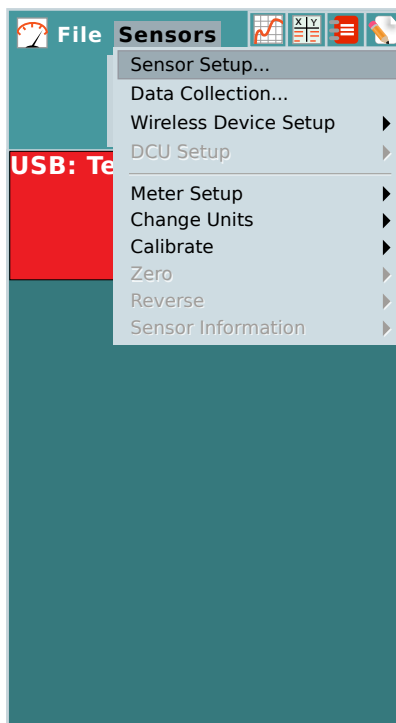

Figure 2. The main screen of the LabQuest connected to the Go!Temp.

- d. Start by setting the interval to 1 s/sample, and the duration to 800 s. This makes the LabQuest record 1 temperature reading from the Go!Temp every second for 800 seconds, for a total of 800 readings. Leave all other settings unchanged. Press OK.

The screenshot shows a 'Data Collection' dialog box with the following settings:

- Mode: Time Based
- Rate: 0.06667 samples/s
- Interval: 1 s/sample
- Duration: 800 s
- Samples to be collected: 800
- Triggers: Disabled
- Advanced: (collapsed)
- Photogate Mode: None

Buttons for 'Cancel' and 'OK' are visible at the bottom.

Figure 3. The Data Collection settings page.

- e. Click on the Graph tab (📊).

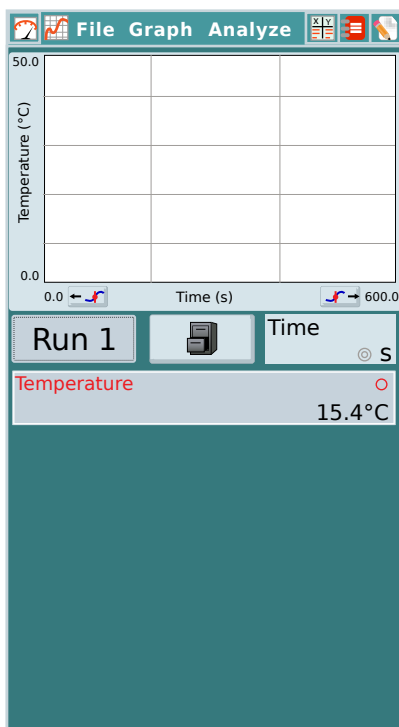

Figure 4. The Graph tab displaying a blank graph.

5. Measure the freezing point of **water**.
  - a. Keep a glass thermometer in the cooling bath. Ensure the bath is at a temperature of  $-10^{\circ}\text{C}$  or less.
  - b. Place the freezing point apparatus in the ice-water bath so that the Go!Temp and the DI water inside the freezing point apparatus are submerged under the ice.

### Hint

One student can stir and read the thermometer while the other records the temperature.

- c. Start the data collection by pressing the Start (▶) button. Collect the necessary data to construct a cooling curve by measuring and recording the temperature and time as the solution cools.

The correct freezing point is when the temperature stops decreasing, or plateaus. Be mindful of potential supercooling effects.

Be sure to consistently stir the sample during data collection.

- d. Press the Stop (■) button to stop data collection once you have reached a temperature plateau.

Write down 4 data points in 15 second intervals. The average of these 4 temperatures will be your freezing point.

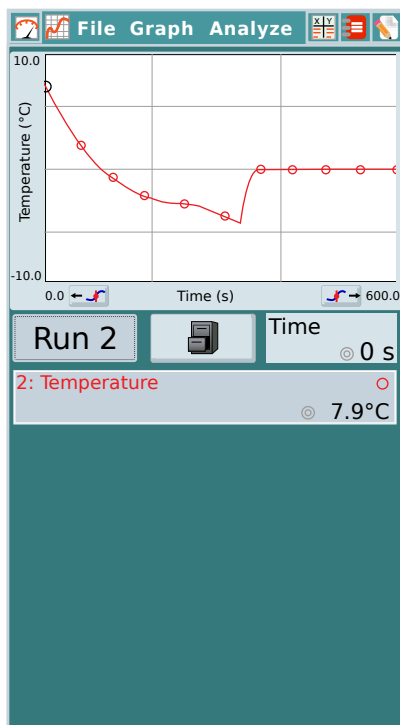

Figure 5. A temperature curve showing the supercooling effect.

### For this lab

- Be sure to consistently stir the sample mixture by raising and lowering the metal stirrer carefully thoroughly thereby maintaining a uniform temperature as the solution cools.
  - Insufficient stirring will cause non-uniform cooling, and stirring too vigorously will cause the solution to splash and freeze on the side of the test tube.
- 
6. Perform at least 3 trials to obtain good precision in your measurements. (The melting points should be within  $0.5^{\circ}\text{C}$  of each other.)  
Freeze and melt the same sample for all trials.
  7. **Clean up:** Melt the sample by placing the test tube in a beaker of room temperature water with stirring until melting is complete. Do not allow the solvent to return to room temperature.
  8. **Save** the solvent and cooling bath for Part II.

**Part II. Determining the Freezing Point Constant for Water**

In this part of the experiment, you will collect data that will allow you to determine the  $K_f$  for water. You can do this by adding a known quantity of solute to the DI water solvent and measuring the freezing point of the mixture.

1. Prepare the **freezing point apparatus**.
  - a. Allow the solution in the freezing point apparatus to warm to room temperature.
  - b. Weigh out 0.4–0.6 g of sodium chloride, NaCl. Record the mass to the nearest thousandth of a gram (0.001 g). Carefully add the solid to the solvent at room temperature. Stir the mixture until the sodium chloride is completely dissolved.
  - c. Reassemble the freezing point apparatus and stir the solution with the metal stirring rod to ensure complete mixing.
2. Prepare the **cooling bath**.
  - a. Measure the temperature of the cooling bath to ensure it is  $-10^\circ\text{C}$  or lower.
  - b. If the ice bath is not cool enough, pour off the water but save the ice and salt mixture.

Repeat the instructions in Part I to prepare the cooling bath, starting with adding more ice to the left-over ice/salt mixture.
3. Measure the freezing point of the **NaCl solution**.
  - a. Keep a glass thermometer in the cooling bath. Ensure the bath is at  $-10^\circ\text{C}$  or less.
  - b. Place the freezing point apparatus in the ice-water bath so that the solution is well submerged. Ensure the thermometer is also submerged in the solvent.
  - c. Collect the necessary data to construct a cooling curve by using the LabQuest and Go!Temp to measure and record the temperature and time as the solution cools.

**Hint**

---

One student can stir and read the thermometer while the other records the temperature.

- d. When you thaw the solution, only allow it to warm about  $5^\circ\text{C}$  **above** its freezing point.

If you let the solution return to room temperature between each trial, this experiment will take an inordinate amount of time.

4. **Clean-up:** After the data has been collected, pour the solution from the freezing point apparatus into sink. Rinse out the test tube, metal stirrer, and your thermometer.
5. **Save** the cooling bath for Part III.

### Part III. Determining the Molecular Mass of Solute

In this part of the experiment, you will design an experiment to determine the molecular mass of an unknown substance.

Your experimental design will be similar to the procedures used in part II. Some unidentified solutes are provided in the laboratory.

There are recommended mass ranges on the bottles, since different solutes will require different masses. Furthermore, the solute may be slow to dissolve. However, complete dissolution is essential for molecular mass determination.

1. Prepare the **cooling bath**.
  - a. Measure the temperature of the cooling bath to ensure it is  $-10^{\circ}\text{C}$  or lower.
  - b. If the ice bath is not cool enough, pour off the water but save the ice and salt mixture. Repeat the instructions in Part I to prepare the cooling bath, starting with adding more ice to the left-over ice/salt mixture.
2. Acquire the unknown. Record the letter of the unknown in your notebook.
3. Determine the molar mass of the unknown.

#### Clean-Up:

- After the data has been collected, pour the solution into sink.
- Clean the freezing point apparatus by rinsing out the test tube, stirrer, and the Go!Temp temperature probe.
- Use the strainer provided in lab to collect the left-over rock salt in the designated container.
- Return the LabQuest and Go!Temp probe to your TA.

## Data Analysis

---

### Parts I & II

1. In calculating  $K_f$ , you must make an assumption about sodium chloride. What is that assumption?
2. Calculate the average freezing point of the pure water.
3. Using the average freezing point of the water, calculate the  $K_f$  of water for each trial performed in Part II.
4. Calculate the average of your  $K_f$  values.
5. Calculate the standard deviation of the average  $K_f$  value.
6. Calculate the 90% confidence limit of your data collected in Part II.
7. Explain why salt is added to the cooling bath. Carefully explain how this works.

### Part III

1. In calculating the molecular mass of the unidentified solute, you must make an assumption about the solute. What is that assumption?
2. For each trial, calculate the freezing point depression,  $\Delta T_f$ .
3. Using the freezing point depression,  $\Delta T_f$ , calculate the molecular mass of the unknown solute, for each trial.
4. Calculate the average molecular mass of the unknown solute.
5. Calculate the standard deviation of the average value.
6. Calculate the 90% confidence limit of your data collected in Part III.

### Conclusion.

Compose a summary of this experiment. Include some comments about the sources of error in the experiment that may be responsible for the difference between the values you have obtained and the accepted literature values for the properties you studied in this experiment.



# Chemical Equilibrium

## Introduction

---

In Chemistry 2A, you were exposed to reactions which essentially went to completion, that is, all the reactants were converted to products. An example of this type of reaction is when HCl is dissolved in water. You know that hydrochloric acid not only dissolves in water but that it also essentially completely dissociates. That is, a 1.0 M HCl solution is often described as being 1.0 M in both the hydrogen ion (or hydronium ion) and the chloride ion. We might write this situation as:

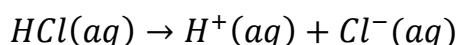

The analogous situation does not occur when the weak acid HF is dissolved in water. While a 1.0 M HF solution certainly does contain the hydrogen (or hydronium) ion and the fluoride ion, it also contains a significant quantity of HF in solution. We might write this as:

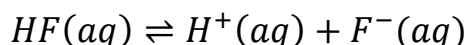

Note the double-arrow symbol we use to indicate that the acid is not completely dissociated. We say that a chemical equilibrium is established in this reaction, and in all reactions which occur but which do not go essentially to completion. Most reactions do not go to completion but instead stop at a chemical position in which both reactants and products are still present. Chemical equilibrium is thus often thought of as a point of chemical balance between the “reactants” and “products”.

One of the important aspects of chemical equilibrium is that it can be established by either starting with reactants or products. That is, the equilibrium point can be established in either direction. This illustrates that chemical equilibrium is dynamic in that reactants are reacting to form products at the same time that products are reacting to form reactants. It is the dynamic competition between these two processes that allows the point of equilibrium to be established.

What would happen if you suddenly placed some additional reactant into a system at equilibrium? Clearly this would affect this dynamic balance and cause a change in the resulting chemical equilibrium position. In fact, when these types of experiments are done it is always observed that the equilibrium will shift in such a way to reduce the concentration of the added reactant, or to “relieve the stress” of the added reactant. This behavior was summarized by Henri Louis Le Châtelier in 1884 and is generally referred to as Le Châtelier’s Principle: when a stress is applied to a chemical system at equilibrium, the equilibrium shifts in a direction that reduces the effect of the stress. In this qualitative experiment you will be exposed to a number of different chemical systems that reach equilibrium and you will observe the effect of an added stress on each system. It is important to make good observations and carefully consider the results and how they relate to the equilibrium topics you are studying in lecture.

**To prepare for this experiment, study the section on chemical equilibrium in your textbook.**

## Procedure

---

**Work in pairs** on this experiment.

The questions for this experiment are integrated with the procedure. Write your answers to these questions in your laboratory notebook as you do the experimental procedure.

### Preparation for Next Lab

---

1. In preparation for the Strong Acid Titration Experiment, each pair of students must obtain about 3 grams of potassium acid phthalate, KHP, in a vial and dry it in the oven at for 2 hours at 110°C.
2. Place the vial of KHP in your 150 mL beaker to keep it from spilling and dry it in the oven at 110°C for 2 hours.
3. After 2 hours, use the beaker tongs to remove your beaker from the oven.
4. Let the beaker cool until it is warm, but safe to handle.
5. Remove the vial from the beaker using your test tube clamp and place it in the center of the desiccator in your locker. If the lid of your desiccator can be removed easily, ask your TA for some vacuum grease to properly seal your desiccator.

### Safety First

---

Remember to wear gloves and use caution whenever handling acids and bases.

**Wear your goggles!**

### Stock Chemicals Used

Chemical	Maximum Amount Used
6 M Hydrochloric Acid	< 15 mL
6 M Sodium Hydroxide	< 15 mL
6 M Acetic Acid	< 5 mL
6 M Ammonium Hydroxide	< 15 mL
1 M Ammonium Chloride	Drops
0.1 M Potassium Thiocyanate	< 5 mL
0.2 M Ferric Nitrate	< 5 mL
1 M Sodium Acetate	< 5 mL
0.5 M Oxalic Acid	< 5 mL
0.25 M Potassium Oxalate	< 5 mL
Saturated Cobalt Chloride, (aq)	< 6 mL
1% Phenolphthalein Indicator	Drops
1% Methyl Orange Indicator	Drops
Potassium Hydrogen Phthalate, (s)	2.5 g



- b. Make sure that you can see through the solution; if the color is too dark you will have trouble observing any color changes as you proceed. You may continue to dilute the solution if it looks too dark. The volume given here is a general guideline.
  - c. Place four 3 mL portions of this solution into four separate test tubes.
3. Add different reagents to the test tubes containing the  $\text{Fe}(\text{SCN})^{2+}$  solution (**NOT** the test tubes with the stock solutions from step 1) and record any color changes observed:
- a. To the first test tube of  $\text{Fe}(\text{SCN})^{2+}$  add 0.5 mL of 0.2 M  $\text{Fe}(\text{NO}_3)_3$  from the stock solution test tube.
  - b. To the second test tube of  $\text{Fe}(\text{SCN})^{2+}$  add 0.5 mL of 0.1 M KSCN from the stock solution test tube.
  - c. To the third test tube of  $\text{Fe}(\text{SCN})^{2+}$  slowly add 6 M NaOH solution drop-wise. You will notice two changes. You should address this in Question A below.
  - d. Use the last test tube of  $\text{Fe}(\text{SCN})^{2+}$  as a reference for comparison.

**Question A:** Compare the color of the solution in each of the four test tubes. Explain the color changes in terms of the equilibria described above and what you believe happened in Step 3.

### Clean-Up

- Pour the content from the test tubes into the waste container in the fume hood labeled "Cation Metal Waste."

## Part II. Equilibria of Acid/Base Indicators

In this procedure, you will study the properties of two acid-base indicators, phenolphthalein and methyl orange. Many indicators are weak acids that establish equilibrium in water:

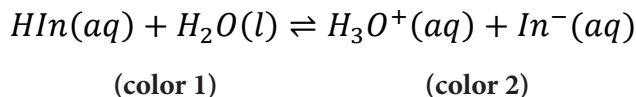

Thus, indicators can be thought of as dyes which change color depending on whether they are in a protonated (HIn) or unprotonated (In<sup>-</sup>) form. In this part of the experiment you will observe the change in the equilibrium position of the indicators by adding acids and bases to solutions that contain these indicators.

1. Place approximately 6 mL of 6 M hydrochloric acid in a labeled test tube.
2. Place 3 mL of deionized water into six test tubes. Add two drops of phenolphthalein to three of the test tubes and two drops of methyl orange to the other three test tubes. Observe the color of the solutions.
3. Add two drops of 6 M HCl to one test tube containing each indicator. Observe any color change.
4. Add 4 drops of 6 M NaOH to another test tube containing each indicator. Observe any color change.

**Question B:** What are the colors of the protonated and unprotonated forms of phenolphthalein?

**Question C:** What are the colors of the protonated and unprotonated forms of methyl orange?

**Question D:** Write the equilibrium expression for each indicator as shown above for HIn. Be sure to indicate the color of each form. Use Hph for the protonated form of phenolphthalein and Hmo for the protonated form of methyl orange.

### Clean-Up

- Save the HCl solution until the end of the experiment.
- Using a small stream of no more than 5 mL of DI water total, rinse the contents of the other test tubes into an 800 mL beaker. Save this solution until Part IV.

### Safety First

Do not rest your hands or arms on the edges of fume hood.

Always keep containers at least 6 inches inside the fume hood.

### Part III. Equilibria of Weak Acids and Bases

In this procedure, you will study the equilibrium properties of weak acids and bases. As described in the chapter on acids and bases, weak acids and bases establish equilibrium with water. In this part you will study this concept by using an acetic acid/acetate ion equilibrium system and the ammonia/ammonium ion equilibrium system. The pertinent equilibria for each system are:

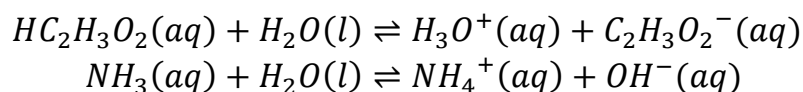

In this part of the experiment, you will observe the change in the equilibrium position through the use of the indicators used in Part I.

#### Procedure for the acetic acid/acetate ion equilibrium

1. Place 3 mL of 0.1 M acetic acid into three test tubes. You will make this solution from 6 M stock solution. Add two drops of methyl orange to each test tube. Observe the color of the solutions.
2. To one of these test tubes add 1.0 M  $\text{NaC}_2\text{H}_3\text{O}_2$  a few drops at a time and observe any color changes. Remember to mix the solution well after each addition. To another test tube, add 6 M acetic acid a few drops at a time and observe any color changes. Again, mix well after each addition. Repeat this step with another sample to confirm your results.

**Question E:** Explain your observations using both the equilibria presented above and the one involving the indicator. What color change did you observe? How is the acetic acid/acetate ion equilibrium affected by adding acetate ion? How does this change affect the concentration of  $\text{H}_3\text{O}^+$ ? How does the change in the concentration of  $\text{H}_3\text{O}^+$  affect the  $\text{H}_{\text{mo}}/\text{H}_{\text{mo}^-}$  equilibrium?

#### Procedure for the ammonia/ammonium ion equilibrium

3. Place 3 mL of 0.1 M ammonium hydroxide into the other three test tubes. You will make this from 6 M stock solution. Add two drops of phenolphthalein indicator to each tube. Observe the color of the solutions.
4. To one of these test tubes add 1 M  $\text{NH}_4\text{Cl}$  a few drops at a time and observe any color changes. Remember to mix the solution well after each addition. Add more 6 M ammonium hydroxide to the test tube a few drops at a time. Mix well after each addition and note any color changes.

**Question F:** Explain your observations using both the equilibria presented above and the one involving the indicator.

- To another test tube containing ammonium hydroxide, add 6 M HCl a few drops at a time and observe any color changes. Remember to mix the solution well after each addition.

**Question G:** Explain your observations using both the equilibria presented above and the one involving the indicator.

#### Clean-Up

- Save the HCl solution until the end of the experiment.
- Using a small stream of no more than 5 mL of DI water total, rinse the contents of the other test tubes into the 800 mL beaker.
- Dissolve approximately 1 gram of sodium bicarbonate in the solution in the beaker. Dispose of the solution in the sink with copious amounts of water.

### Part IV. Temperature Effects on Equilibria

In this procedure, you will again study the properties of a chemical system containing a complex ion. The system in this study of the temperature effects on equilibria can be described as:

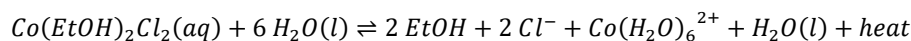

(blue)

(red-pink)

EtOH is the abbreviation for ethanol— $\text{CH}_3\text{CH}_2\text{OH}$ . You will note that “heat” has been shown to be a “product” of the reaction as it is read from left to right. In other words, as the reaction occurs from left to right the system gives off energy in the form of heat. Thus, the system will change color depending on whether heat is added or removed from the system.

- Fill a 400 mL beaker half way with ice. Add a small amount of water.
- Acquire a capped test tube containing 1% cobalt chloride dissolved in 95% ethanol. Place the test tube inside the ice bath, be careful to leave half the solution above the ice. Observe the color change.
- Remove the test tube from the ice water bath and allow it to warm back to room temperature. Observe the color change.
- Return the test tube to your TA.

**Question H:** Explain the color changes in terms of the equilibria described above.

#### Safety First

Ethanol is a flammable liquid. Keep the test tube capped and keep the test tube away from sources of ignition.

### Part V. Equilibria of Precipitation Reactions

In this procedure, you will study the properties of two chemical systems involving the oxalate anion,  $C_2O_4^{2-}(aq)$ . The chemical sources of the oxalate ion are calcium oxalate,  $CaC_2O_4(s)$ , and the weak diprotic acid, oxalic acid,  $H_2C_2O_4(aq)$ . This system is particularly interesting because 3 simultaneous equilibria occur in water. The equilibria in water that are important can be described as:

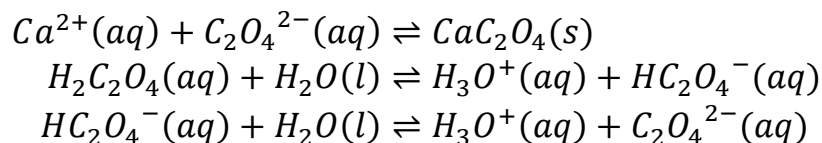

Clearly, this is a more complex system than we have thus far encountered. However, we should be able to qualitatively understand the system. For example, if you wanted to precipitate the calcium with oxalate, would you want the solution to be basic or acidic based on the equilibria described above? Take a guess! Now let's see if you are right.

1. Mix 4 mL of 0.1 M  $CaCl_2$  with 4 mL of deionized water in a small beaker. Split the resulting solution into three approximately equal portions in three separate test tubes.
2. Add 15 drops of 0.2 M  $K_2C_2O_4$  solution to one of the test tubes containing calcium chloride. Observe the results.
3. Add 6 drops of 0.5 M  $H_2C_2O_4$  solution to one of the other test tubes containing calcium chloride. Observe the results.

**Question I:** Even though you added the same stoichiometric amount of oxalate ion to these test tubes you have observed differing amounts of precipitate. Why?

4. Now add 10 drops of 6 M HCl to the solution of calcium chloride and oxalic acid. Observe the results.

**Question J:** Explain the results in terms the equilibria discussed above.

5. Now slowly add 20 drops of 6 M  $NH_4OH$  to this test tube until a change occurs.

**Question K:** Explain the results in terms the equilibria discussed above.



6. You may wonder if the precipitate in Step 5 is really an oxalate or a hydroxide precipitate. This can be checked by adding 20 drops of 6 M  $\text{NH}_4\text{OH}$  to the solution in the last remaining test tube containing calcium chloride. Observe the results.

**Question L:** Do you believe the precipitate is calcium oxalate or calcium hydroxide? Explain.

#### Clean-Up

- Using a small stream of no more than 5 mL of DI water total, rinse the contents of all test tubes into the 800 mL beaker.
- Dissolve approximately 1 gram of sodium bicarbonate in the solution in the beaker.
- Dispose of the solution in the sink with copious amount of water.

#### Conclusion.

Briefly discuss interpretations of your observations and results. Discuss how your observations illustrated Le Châtelier's principle. Discuss how reactant concentrations change as equilibrium reactions shift to the left or the right. Likewise, discuss how product concentrations change as equilibrium reactions shift to the left and the right. Explain using your observations in part V if you would prepare a calcium oxalate precipitate in acidic or basic solution.



# Strong Acid – Strong Base Titration

## Introduction

---

This experiment and the next three following experiments permit you to explore most of the important aspects of acid-base chemistry. We start with an exploration of the classic acid-base reaction, that of a strong acid with a strong base. The solutions you prepare in the strong acid-strong base experiment will be used as standardized solutions when you explore the additional complexities of a weak-acid titration curve experiment and the titration of a polyprotic acid experiment. Buffers constructed to exploit a property of the weak-acid titration curve are then explored in the fourth of these related experiments.

In this experiment you will be analyzing the neutralization between a strong acid and a strong base, using the titration skills learned in the earlier parts of this lab. According to the **Arrhenius Acid-base Theory**, when dissolved in water, an acid raises the concentration of hydrogen ion, or  $H^+$ , while a base raises the concentration of hydroxide ion, or  $OH^-$ . When reacted together, the acid and base will neutralize each other according to the net ionic equation (1).

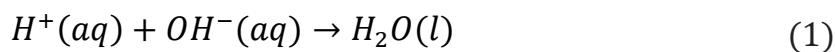

An acid is considered to be strong if it completely ionizes in water. In this lab, you will be utilizing the strong acid, hydrochloric acid or  $HCl$ , to neutralize the strong base, sodium hydroxide or  $NaOH$ , according to the neutralization reaction below.

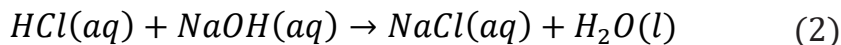

The progression of the reaction will be observed using a pH meter and a titration curve will be created using the experimental data. You will start with a sample containing only the acid and indicator and slowly add your standardized base. A **titration curve** is simply a plot of the pH of an acid versus the volume of base added, or vice versa.

The titration curve gives a good description of how an acid-base reaction proceeds. The pH will start out low and acidic, then increase as it approaches the **equivalence point**, where the concentration of acid equals that of the base. Then as the solution becomes more basic, it will slowly rise and level off as an excess amount of base is added.

Note that the equivalence point is slightly different from the endpoint of a titration. The **endpoint** is when the indicator changes color. This **does not** always correspond to the equivalence point.

**As pre-laboratory preparation, it is critical that you review the ideas on strong acid-strong base titration presented in your textbook.**

## Procedure

---

**Work in pairs** on this experiment.

Each student must collect data and submit a separate report. The actual data analyses and the written reports must be done entirely independently of your lab partner or other students. Make sure that you avoid unauthorized collaboration and plagiarism. All suspected violations of the Code of Academic Conduct will be referred to Student Judicial Affairs.

### Safety First

Remember to wear gloves and use caution whenever handling acids and bases.

**Wear your goggles!**

### Stock Chemicals Used

Chemical	Maximum Amount Used
Potassium acid phthalate (KHP)	2.5 g
6M Hydrochloric Acid	According to calculation (< 30 mL)
6M Sodium Hydroxide	According to calculation (< 30 mL)
1% Phenolphthalein Indicator	Drops
pH Meter Calibration Buffer, pH 4 (red)	< 5 mL
pH Meter Calibration Buffer, pH 7 (yellow)	< 5 mL
pH Meter Calibration Buffer, pH 10 (blue)	< 5 mL

### Part I. Preparing your Solutions

You will prepare about 500 mL of approximately 0.2 M sodium hydroxide solution and 500 mL of approximately 0.2 M hydrochloric acid from 6.0 M stock solutions. Perform this calculation in the lab note book as part of the pre-lab exercise.

1. Preparing the 0.2 M NaOH solution:
  - a. Label a 1 L bottle as 0.2 M NaOH.
  - b. Estimate approximately 400 mL of DI water using a beaker and transfer it to the 1 liter plastic bottle.
  - c. Estimate the volume of 6.0 M NaOH needed using a graduated cylinder, then quantitatively transfer the sodium hydroxide to a clean 150 mL beaker using a water bottle filled with DI water.
  - d. Add DI water until the volume reaches 100 mL. Transfer this solution to the 1 liter plastic bottle.
  - e. Cap the bottle securely, and mix the contents thoroughly by inverting the bottle and swirling it repeatedly. The bottle should be shaken at least 50 times in total.

2. Preparing the 0.2 M HCl solution:
  - a. Label another 1 L bottle as 0.2 M HCl.
  - b. Estimate approximately 400 mL of DI water using a beaker and transfer it to the 1 liter plastic bottle.
  - c. Estimate the volume of 6.0 M HCl needed using a graduated cylinder, then quantitatively transfer the hydrochloric acid to a clean 150 mL beaker using a water bottle filled with DI water.
  - d. Add DI water until the volume reaches 100 mL. Transfer this solution to the 1 liter plastic bottle.
  - e. Cap the bottle securely, and mix the contents thoroughly by inverting the bottle and swirling it repeatedly. The bottle should be shaken at least 50 times in total.

**Safety First**

Always add acid to water, and never the reverse.

**Clean-Up:**

- Using less than 5 mL of DI water, rinse any excess 6.0 M HCl and 6.0 M NaOH into an 800 mL beaker.
- Save this solution for the clean-up procedure at the end of lab.

### Part II. Standardizing the base against Potassium Acid Phthalate

In this step of the experiment, you will standardize your sodium hydroxide solution against the primary standard, potassium acid phthalate, KHP. You will also use a technique called weighing by difference. This is a very important technique to use because it eliminates systematic errors from the balance. Be sure to use the same balance so that systematic errors in the balance will continue to be eliminated when you take the difference readings between masses.

#### Weighing by difference

- This technique eliminates systematic errors from the balance during weighing.
- First, measure the mass of the container with the material from which you are going to draw your sample. Then, remove some of the material and place it in a separate container. Re-measure the mass of the original container and the remaining material.
- Calculate the mass removed, and repeat the process until you have removed the mass desired.

- 
1. Prepare the titration vessels:
    - a. In a previous lab, you obtained about 3 g of primary standard grade potassium acid phthalate (KHP) in a vial, dried it in an oven for 2 hours at 110°C, and stored it in a desiccator for use today.
    - b. Accurately weigh a 0.5–0.6 g sample of dry KHP onto a weighing boat. Using the appearance of this sample as a guide, accurately weigh by difference 3 more samples onto weighing boats.
    - c. Quantitatively transfer the first sample from the weighing boat into a 250 mL beaker with the help of a small stream of DI water from your wash bottle, and then add water to a total of about 30 mL and swirl it gently until the KHP dissolves. Transfer the other 3 samples of KHP into small Erlenmeyer flasks using the same procedure.
  2. Perform a cursory titration using your KHP sample in a 250 mL beaker.
    - a. Read and understand how to fill and use a buret by reading the Common Laboratory Procedures section in the Appendix of this manual. Failure to properly fill the buret properly can result in spills and injuries.
    - b. Condition and fill a 25 mL buret with the NaOH solution you prepared in Part I. You will now standardize this solution.

#### Lab Skill Tips

Read the buret at or slightly below eye level. Do not hold your hands or lab manual behind the buret.

You can hold a sheet of colored paper behind the buret to read the meniscus clearly.

### Buret Usage Tips

---

- Do not waste time trying to hit 0.00 with the meniscus. Fill the buret to slightly below the zero mark and read and record the actual starting point to the nearest 0.02 mL.
  - Be careful when filling the buret. Only one person should be filling the buret. Be sure the stopcock is closed before filling.
  - Use a 100 or 150mL beaker to fill the buret. **Never** use flasks, 1L plastic bottles, or large beakers to fill the buret.
  - Be sure always to wipe off the tip of a buret before you begin a titration. Use a laboratory tissue and make one quick stroke downward beginning at the stopcock and ending in the air beyond the buret tip.
- 
- c. Add three drops of phenolphthalein indicator and a stir bar to the first KHP solution.
  - d. Place the flask onto the stir plate underneath the buret and turn on the stirrer and slowly increase the stirring speed. Don't use the heat control knob on the hot plate. Lower the buret tip well into the 250 mL beaker.
  - e. Perform a cursory titration to determine the approximate endpoint of the titration. If the masses of KHP are approximately the same then the endpoint of each sample will occur at approximately the same volume.
  - f. After you have reached your endpoint for your cursory titration record the buret reading at the endpoint and calculate the volume of NaOH needed to reach the endpoint.
  - g. Retrieve, clean, and dry your magnetic stir bar for your next titration using the magnetic rod at the center sink. Pour the solution in the titration flask into an 800 mL beaker.
3. Perform a series of duplicate, precise titrations:
    - a. From your cursory titration, you know the approximate position of the endpoint. Now you will perform a more precise titration using the following guidelines.
    - b. Initially add the titrant fairly rapidly, pausing every few milliliters to allow the solution to mix thoroughly. Pay attention to the region where the two solutions mix and as the indicator color begins to trail out into the solution as you stir, reduce the next amount of titrant added, keeping in mind the target volume. Stop adding titrant about 1 mL short of this volume.

## Strong Acid - Strong Base Titration

- c. Gently wash down the walls of the flask with water from your wash bottle, and then resume adding base from the buret but now dropwise. As you approach the endpoint, the pink color will increasingly linger. You should frequently wash down the interior sides of the flask to recover any reagent drops that may be clinging to the sides. Stop adding base when the entire flask has a *faint* pink color that persists.
  - d. You may wish to record the buret volume of several successive drops as you approach the endpoint in case you discover that you have overshot the endpoint. Record the final buret reading to the nearest 0.02 mL.
  - e. Refill the buret and similarly titrate the remaining two KHP samples.
  - f. Clean up by pour the solution in the titration flasks into your 800 mL beaker.
4. Calculating the concentration of your NaOH solution:
- a. It should be clear to you that the ratio of the NaOH titration volume to the mass of KHP being titrated should be a constant.
  - b. Calculate this ratio for your three latter titrations and determine if one of them fails the Q-test. If it does, run another sample. You should discard the data from the first cursory titration since this titration was performed quickly.
  - c. When you have three samples that can be retained, you may begin Part III.



### Part III. Strong Acid-Strong Base Titration Curve

This part of the experiment requires the use of a pH meter to measure the pH of various solutions. The pH meter and the accompanying electrode are both very expensive and fragile. Treat both pieces of equipment with great care. Read and understand the pH meter operation instructions in the the Common Laboratory Procedures section of Appendix of this manual. Follow the directions provided very carefully.

#### Care of pH meter and pH electrodes

- Keep the tip of the electrode submerged in solution at all times.
- Never leave the electrode in deionized water.
- When rinsing the electrode use a light stream of deionized water.
- Be careful of the electrode when adding strong base or when stirring the solution. Do not stir using the electrode.
- After completing the experiment, **store the electrode in the storage solution provided.** Additional storage solution is available in the laboratory if needed.

The information you generate in this part of the experiment has two goals: 1) to standardize the approximately 0.2 M HCl solution, and 2) to demonstrate the classic titration curve of acid-base chemistry. You will be doing the titration procedure at least twice. The first titration will familiarize you with the critical pH and volumes for your specific solutions' concentrations, after which you may adjust your technique to more accurately locate the endpoint for the specific solutions you are using.

1. Calibrate the pH meter.
  - a. The pH meter will need to be calibrated before starting the experiment. There is no need to recalibrate later during the experiment.
  - b. Dispense the pH 4.00, pH 7.00, and pH 10.00 buffers into the mini buffer bottles, taking care not to overfill.

Standardize the pH meter using the three buffer solutions following the procedure outlined in the Appendix of this manual, pH Meter Operating Instructions.

**Always** keep the pH electrode in the electrode storage solution when not in use.

#### Lab Skill Tips

Use the mini buffer bottles to store the pH calibration buffer solutions.

## Strong Acid - Strong Base Titration

2. Prepare the titration vessel.
  - a. Use your volumetric pipets to quantitatively transfer 15.00 mL of the approximately 0.2 M HCl solution you prepared in Part I into a 150 mL beaker. Without measuring precisely, add about 15 mL of deionized water to this beaker. Place a magnetic stir bar into the beaker gently so no reagent splashes.
  - b. Place a magnetic stir plate under a buret clamp that is adjacent to the pH meter you have just standardized near your work area and place the beaker on the stir plate.
  - c. Use the previously conditioned buret from Part II filled with the approximately 0.2 M NaOH solution that you standardized in Part II and clamp it in place above the beaker.
  - d. Clamp the pH electrode in place below the level of the liquid in the beaker and away from the stir bar. Adjust the position of the buret tip so that it is inside the beaker, away from the side but with the stopcock at a convenient location for you to manipulate. Position the beaker so that the stir bar is somewhat displaced away from the center of the beaker to allow room for the pH electrode but make sure that the stir bar is above the center of the stir plate.
3. You will now standardize the HCl solution by titrating it with the previously standardized NaOH solution, and following the course of the acid neutralization reaction by monitoring the pH with the pH meter.
4. Begin with a quick titration.

To do so, you will add the titrant (0.2 M NaOH) in small increments, and recording the volume reading in the buret and the pH reading from the pH meter in your note book.

Follow the instructions closely and add the titrant in the correct increments.

- a. When the assembly is complete, turn on the stir motor (left knob) slowly so that the stir bar is rotating at a smooth, moderate speed and clears the pH electrode. Do **NOT** turn on the heat.
- b. Perform a quick titration by adding the titrant in 1 mL increments until you reach pH 2.5; then 0.10 mL (2 drops) increments until you reach pH 10.7. After that, add 1 mL increments until pH 11.5. Stop the titration when you have reached pH > 11.5.
- c. When the titration is complete, pour the solution from the titration vessel into the 800 mL beaker.

## Titration Hints

---

- **DO NOT** use your wash bottle to rinse down the sides of the beaker, as any added volume will change the pH readings and invalidate the titration curve data being collected.
- Record your buret readings after the addition of each increment.
- Allow time for the reaction vessel to become equilibrated and for the pH reading to become stabilized and then record the pH value in your notebook alongside the buret reading.

- 
- d. To find the endpoint, first convert your buret readings to volumes of NaOH added. Determine between which 2 volumes the largest change in pH occurs. The **endpoint** is between the volume readings where the largest pH change occurred.
5. Set up your second titration by repeating step 2.
  6. Your second titration should be more carried out more precisely.

Refine your procedure based on your first titration by adding 1 drop of NaOH at a time from well below the endpoint to well above the endpoint. Record your buret readings after the addition of each increment.

Allow time for the reaction vessel to become equilibrated and for the pH reading to become stabilized and then record the pH value in your notebook alongside the buret reading.

- a. Turn on the stir motor (left knob) slowly so that the stir bar is rotating at a smooth, moderate speed. If necessary, adjust the position of the pH electrode so that it does not touch the stir bar. Do **NOT** turn on the heat.
  - b. Begin by adding the titrant in 1 mL increments until you are approximately 2 mL away from the end point. Record the volume and pH reading at each increment.
  - c. Now, add the titrant in drop-wise increments. Stop the titration when you have reached  $\text{pH} > 11.5$ .
  - d. When the titration is complete, pour the solution from the titration vessel into the 800 mL beaker.
7. Repeat the titration procedure as time allows so that you have as many trials as possible to improve the statistics of your standardization of HCl.

## Hint

---

When collecting data, leave an empty column between the buret reading and the pH in which to place the volume of NaOH added (difference between present buret reading and initial buret reading).

### Clean-Up

- Tightly cap and store the bottles containing the standardized NaOH and HCl solutions for use in later experiments.
- Drain the remaining NaOH from the buret into the 800 mL beaker. Add any left-over KHP, and any excess 6 M HCl into the 800 mL beaker.
- Slowly and carefully, add 1 gram of sodium bicarbonate to the solution in the 800 mL beaker.
- Pour the solution into the sink with copious amount of water.

▶ **SAVE your standardized 0.2 M HCl and 0.2 M NaOH. You will use these solutions for the next 3 experiments.**

## Data Analysis

---

### Part I

1. Calculate the volume of 6 M NaOH stock solution needed to prepare the 500 mL of 0.2 M NaOH? This should be the same volume of 6 M NaOH you used in part I.
2. Calculate the volume of 6 M HCl stock solution required to prepare the 500 mL of 0.2 M HCl? This should be the same volume of 6 M HCl you used in part I.

### Part II

1. Calculate the molarity of the NaOH solution as determined by the titration for each of the three acceptable trials. NOTE: KHP has the actual chemical formula  $\text{KHC}_8\text{H}_4\text{O}_4$ , formula mass = 204.23 g.
2. Calculate the average molarity of the NaOH solution.
3. Calculate the standard deviation of the average molarity of NaOH solution.
4. Calculate the 90% confidence interval for the reported molarity.

### Part III

1. How many trials did you perform to determine the titration curve for the neutralization of HCl by NaOH?
2. Use a spreadsheet program such as Excel to enter your titration data and make your titration curves by plotting pH vs. volume of added NaOH solution.

Enter the volume of NaOH as a column headed V and the pH as an adjacent column headed pH.

Leave four empty columns to the right of each curve for developing the derivative curves in question 9. Head these columns with the labels Vm, D1, Vd, and D2. Use the plot wizard to create a plot from the first two columns.

Make sure you use the type of plot that will accept both a randomly spaced x value and a corresponding y value. Such plots are called scatter plots in commonly used spreadsheet programs. Use this plot to estimate the position of the endpoint (that volume of NaOH which is midway between the two nearly linear asymptotic regions at low pH and at high pH).

What is your best estimate of the volume of NaOH at the endpoint for each of your titration curves based on this plot?

3. A property of the equivalence point of an acid-base titration curve is that it is the volume at which the rate of change of pH is greatest (the first derivative reaches a maximum). It is also the volume at which there is an inflection point in the curve (the second derivative will change sign).

## Strong Acid - Strong Base Titration

These first and second derivative plots, which we will approximate by calculating and plotting forward divided difference curves, can help you identify this volume, perhaps more precisely than you can from the direct plot of pH vs. NaOH volume.

Following the directions below, use your spreadsheet program to calculate the forward divided difference approximation to the first derivative (rate of change) of the titration curve and the second forward divided difference approximation to the second derivative (rate of change of the rate of change) of the titration curve. Sample data and plots are shown below.

The first forward divided difference best represents the derivative or rate of change of the titration curve at the volume midway between volumes  $V_i$  and  $V_{i+1}$ . Here  $i$  is one of the data points and  $i+1$  is the next data point in the sequence. In the column immediately to the right of the pH values, enter the formula that will calculate the volume midway between  $V_i$  and  $V_{i+1}$ ,

$$Vm_i = \frac{(V_i + V_{i+1})}{2}$$

The forward divided difference approximation for a series of data points of the type pH<sub>*i*</sub>,  $V_i$  is given by:

$$D1_i = \frac{(pH_{i+1} - pH_i)}{(V_{i+1} - V_i)}$$

In the column to the right of  $Vm$ , enter the formula for  $D1$ . It is easy to set up a formula by referencing the data in the cells for pH<sub>*2*</sub>, pH<sub>*1*</sub>,  $V_2$ , and  $V_1$  to calculate this forward difference for the first data point in the sequence in a column adjacent to the pH of the first point. This formula may then be copied down the column and the spreadsheet will update the references to the correct cells for the pH and Volume for each row automatically. The column then is the forward divided difference approximation to the derivative. Notice that you will not be able to calculate a forward difference for the last row of the data since there are no data values beyond the last row to use for pH<sub>*N+1*</sub> or  $V_{N+1}$ .

Likewise in the next column enter the formula for the volume midway between  $Vm_i$  and  $Vm_{i+1}$  given by,

$$Vd_i = \frac{(Vm_i + Vm_{i+1})}{2}$$

Then in the next and final column to the right, enter the formula for the second forward divided difference approximation to the second derivative (rate of change of the rate of change)

$$D2_i = \frac{(D1_{i+1} - D1_i)}{(Vm_{i+1} - Vm_i)}$$

Invoke the plot wizard to plot the first forward divided difference ( $D1$ ) vs.  $Vm$ , and then again to plot the second forward divided difference ( $D2$ ) vs.  $Vd$ . These approximations to the first and second derivative illustrate the properties, mentioned above, of the titration curve.

The forward divided difference expressions do tend to amplify experimental error (commonly called noise), but your data should be good enough that these plots of the forward divided

differences can help you to identify the equivalence point. You will find some plots at the end of this section of the laboratory manual that work up the first and second forward divided difference plots for some old titration data. You can see what the expressions do to the data. Your plots should look similar to one another. **Check with your teaching assistant to see how they want the graphs turned in (i.e. by email or printed copies). Make sure your name is on each graph and that you have clearly titled and labeled the vertical and horizontal axes. If you completed 3 trials, you should have 9 graphs.**

4. Using the combined representations of the titration curves developed in questions 8 and 9, what is your best estimate of the equivalence point volume of NaOH for each of your titration curves? You should be able to make this estimate to within 0.02 mL eg. 18.46 mL.
5. Using the average molarity of your NaOH solution from Part II, and the equivalence point volume of NaOH determined from the derivative plots, calculate the molarity of your HCl solution for each trial to four significant figures, eg. 0.2314 M HCl.
6. Calculate the average molarity of your HCl solution. Keep the average values of your standardized NaOH and HCl solutions in a prominent place in your notebook and perhaps write the value on the bottle labels. You will need these values in subsequent experiments.

### Conclusion

Think about the standardization of NaOH, the titration curves, the forward divided difference approximation (derivative) treatment of the data, and the standardization of your HCl solution. Compose a summary paragraph that describes today's experiment and your understanding of acid-base neutralization reactions.

### Sample Data and Plots

Some sample graphs of the first and second derivatives of curves have been provided. The graphs are based on dummy data. A graph of the titration curve and of the first and second derivative curves of this data have been provided. Your graphs should have the same main features as the following graphs, although they will vary because your data will be different from this.

The first curve is just the titration curve. It is based on the data presented on the following page. As you can see, there is some room for error in estimating the precise volume for the equivalence point.

It is because of this difficulty in estimating the equivalence point that the two “derivative” curves are plotted. When the first derivative vs. NaOH Volume ( $D1$  vs.  $V_m$ ) is plotted, a strikingly different curve is the result. In this curve, the equivalence point shows up as a large spike on the graph. The equivalence point of the titration is the maximum point on this curve.

The second derivative plot ( $D2$  vs.  $V_d$ ) is also made for convenience. When this plot is made, the equivalence point is the value of the volume for which the plot passes through the x-axis. Both curves are useful in more accurately determining the equivalence point of titrations.



**TITRATION EXAMPLE:** Titration of 15 mL HCl with 0.20 M NaOH

<u>mL NaOH (Vol)</u>	<u>pH</u>	<u>V<sub>m</sub></u>	<u>D1</u>	<u>V<sub>d</sub></u>	<u>D2</u>
5.00	1.93				
10.00	2.15	7.5	0.04		
15.00	2.5	12.5	0.07	10	0.0052
16.00	2.63	15.5	0.13	14	0.02
17.00	2.8	16.5	0.17	16	0.04
18.00	2.87	17.5	0.07	17	-0.1
19.00	2.9	18.5	0.03	18	-0.04
19.10	3.09	19.05	1.9	18.78	3.4
19.20	3.11	19.15	0.2	19.1	-17
19.30	3.16	19.25	0.5	19.2	3
19.40	3.37	19.35	2.1	19.3	16
19.50	3.62	19.45	2.5	19.4	4
19.60	4.24	19.55	6.2	19.5	37
19.70	7.33	19.65	30.9	19.6	247
19.80	9.88	19.75	25.5	19.7	-54
19.90	10.35	19.85	4.7	19.8	-208
20.00	10.57	19.95	2.2	19.9	-25
21.00	11.31	20.5	0.74	20.23	-2.6546
22.00	11.61	21.5	0.3	21	-0.44
23.00	11.8	22.5	0.19	22	-0.11
24.00	11.91	23.5	0.11	23	-0.08
25.00	11.56	24.5	-0.35	24	-0.46
26.00	11.6	25.5	0.04	25	0.39
27.00	11.68	26.5	0.08	26	0.04
28.00	11.72	27.5	0.04	27	-0.04
29.00	11.77	28.5	0.05	28	0.01

# Strong Acid - Strong Base Titration

## Titration Curve (vol of NaOH vs. pH)

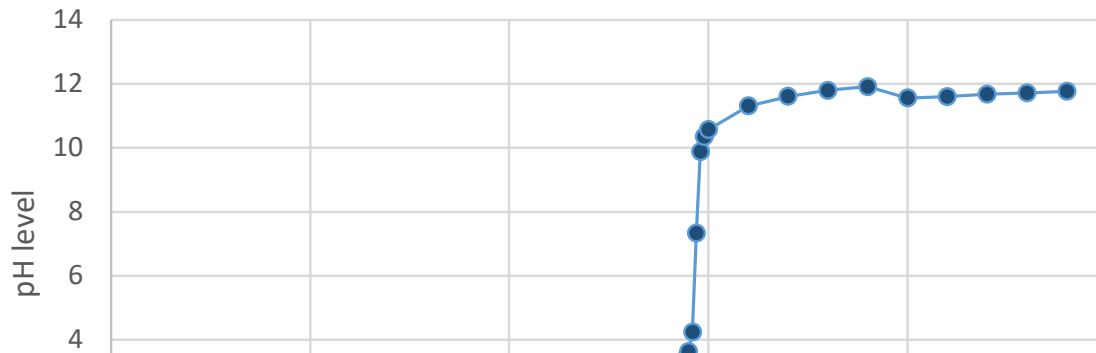

## First Derivative

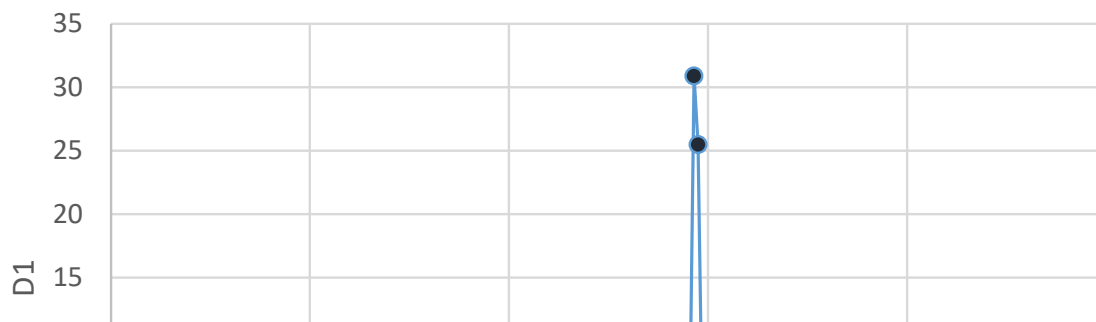

## Second Derivative

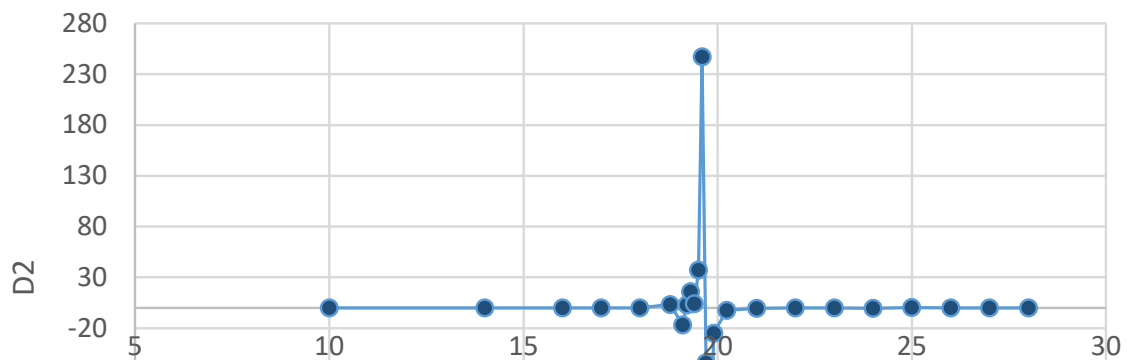

# Acid Dissociation Constants and the Titration of a Weak Acid

## Introduction

---

One of the most important applications of equilibria is the chemistry of acids and bases. The **Brønsted-Lowry acid-base theory** defines an **acid** as a species that donates a proton and a **base** as a species that accepts a proton. In the case of an aqueous solution of a strong acid, such as HCl, the acid reacts completely with the water and dissociates into the hydronium ion,  $\text{H}_3\text{O}^+$ , and the chloride ion,  $\text{Cl}^-$  as shown by

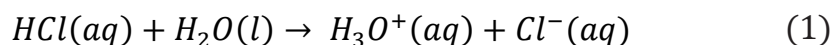

In this reaction, HCl is the **Brønsted-Lowry acid** and  $\text{H}_2\text{O}$  is the **Brønsted-Lowry base**. In an aqueous solution of HCl, the associated species, HCl, does not exist. The species present are  $\text{H}_3\text{O}^+$ ,  $\text{Cl}^-$ , and  $\text{H}_2\text{O}$ . Since this reaction essentially goes to completion, a single-headed arrow pointing to the right is used in the chemical equation.

Unlike strong acids, aqueous solutions of weak acids **do not** completely dissociate into the hydronium ion and the corresponding anion but instead reach **equilibrium**. If we let HA symbolize a weak acid, then the equilibrium reaction of a weak acid with water is represented by

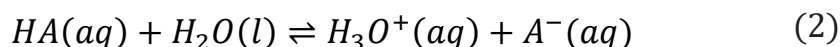

Similarly, in this reaction, HA is the Brønsted-Lowry acid and  $\text{H}_2\text{O}$  is the Brønsted-Lowry base. In an aqueous solution of HA, the species present are the associated species, HA, the hydronium ion,  $\text{H}_3\text{O}^+$ , the anion,  $\text{A}^-$ , and  $\text{H}_2\text{O}$ . Note that double arrows pointing in opposite directions are used in the chemical equation since this reaction does not go to completion but instead reaches equilibrium.

HA and  $\text{A}^-$  are also referred to as a **conjugate acid-base pair** where HA is the acid and  $\text{A}^-$  is its conjugate base, formed when HA donates its proton. The species  $\text{A}^-$  is also considered to be a Brønsted-Lowry base since it can accept a proton. The species that make up a conjugate acid-base pair only differ in structure by the presence of a single proton,  $\text{H}^+$ . Likewise,  $\text{H}_2\text{O}$  and  $\text{H}_3\text{O}^+$  also constitute a conjugate acid-base pair where  $\text{H}_3\text{O}^+$  is the conjugate acid of  $\text{H}_2\text{O}$ .

Since equation (2) is an equilibrium reaction, we can write an equilibrium constant expression as shown below

$$K_a = \frac{[\text{H}_3\text{O}^+][\text{A}^-]}{[\text{HA}]} \quad (3)$$

## Acid Dissociation Constants and the Titration of a Weak Acid

The equilibrium constant,  $K_a$ , is called the **acid dissociation constant**. Recall that water is not included in the equilibrium constant expression since it appears in the reaction as the pure liquid. The magnitude of the dissociation constant provides information regarding the degree of dissociation of the acid in water. For example, the  $K_a$  values for HF and HCN are  $7.2 \times 10^{-4}$  and  $4.0 \times 10^{-10}$ , respectively. The larger  $K_a$  value of HF indicates that the equilibrium reaction between HF and  $H_2O$  (4) lies further to the right than the equilibrium reaction between HCN and  $H_2O$  (5).

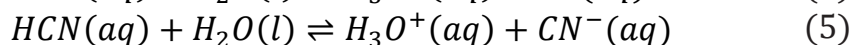
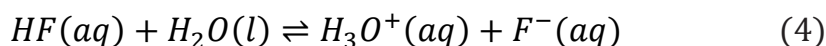

In other words, HF dissociates into the hydronium ion,  $H_3O^+$ , and its conjugate base,  $F^-$ , to a greater extent than does HCN. If we had a bottle of 0.1 M HF and a bottle of 0.1 M HCN, then the hydronium ion concentration would be higher in the bottle of HF than in the bottle of HCN; therefore, the pH would be lower in the bottle of HF.

Due to the establishment of equilibrium between a weak acid and its conjugate base in an aqueous medium, the pH changes that take place when titrating a weak acid with a strong base are significantly different than the pH changes that take place when titrating a strong acid with a strong base. As a result, the titration curve of a weak acid has a slightly different shape than the titration curve of a strong acid. For example, when a strong acid is titrated with a strong base, the equivalence point is found to occur at  $pH=7$ . However, when a weak acid is titrated with a strong base the equivalence point does not occur at neutral pH. You will also find other significant differences between the two titration curves due to equilibrium reactions.

Let us consider in more detail how pH will change when small amounts of strong base are added to an aqueous solution of a weak acid, HA. Before any strong base is added to the weak acid, the concentration of the hydronium ion can be assumed to originate only from the dissociation of the weak acid.

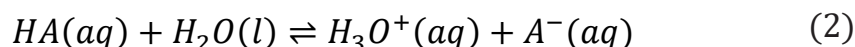

The assumption here is that the amount of hydronium ion resulting from the dissociation of water

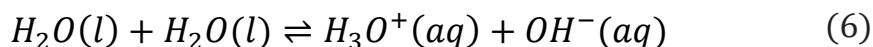

is **very small** relative to the other sources of hydronium and can be neglected. This is a good assumption since the equilibrium constant,  $K_w$ , at  $25^\circ C$  for this reaction is equal to  $1.0 \times 10^{-14}$ . Therefore, the pH then corresponds to the  $[H_3O^+]$  as a result of the dissociation reaction represented by equation (2). Furthermore, for every mole of  $H_3O^+$  that forms, one mole of  $A^-$  is produced and one mole of HA dissociates.

Therefore, at equilibrium,  $[H_3O^+] = [A^-]$  and  $[H_3O^+]$  represents the concentration of HA that is lost in the dissociation. Once the initial concentration of HA is known, then the equilibrium

concentrations of  $H_3O^+$ ,  $A^-$ , and HA can be calculated, as well as the  $K_a$  value of the weak acid from a measured pH value.

As base is added, the  $OH^-$  ion will react with the major species in solution, HA, to produce more conjugate base,  $A^-$ .

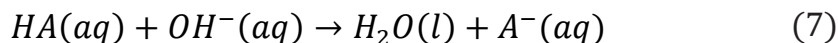

This reaction can be assumed to go to completion followed by the re-establishment of the dissociation equilibrium:

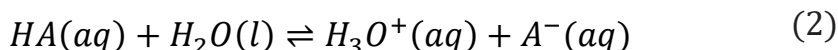

If the equivalence point has not been reached, then the number of moles of leftover HA will be equal to the original number of moles of HA minus the number of moles of  $OH^-$  added. The moles of HA lost in the dissociation reaction, shown by equation (2), is negligible compared to the number of moles of leftover HA.

[HA] then is calculated by dividing the number of leftover moles of HA by the total volume of the mixture at this point in the titration.  $[H_3O^+]$  is determined by the number of moles of  $H_3O^+$  formed in the dissociation reaction and is simply measured by pH. (Again, assuming that any  $[H_3O^+]$  formed from the dissociation of water is negligible.)  $[A^-]$  is equal to the number of moles of  $A^-$  formed in the strong base reaction, shown by equation (7), divided by the total volume of the mixture. Like HA, the number of moles of  $A^-$  produced in the dissociation reaction is negligible.

Another point of interest on a weak acid titration curve, other than the equivalence point, is the **midpoint**. The midpoint occurs when  $\frac{1}{2}$  of the original acid, HA, has reacted with all the strong base,  $OH^-$ , that has been added. At the midpoint, the number of moles of the conjugate base,  $A^-$  is equal to the number of moles of weak acid, HA, remaining in the solution and thus,  $[HA] = [A^-]$ . Applying this to equation (3), we obtain  $K_a = [H_3O^+]$  and taking the negative log of each side, the equality is expressed as  $pH = pK_a$ . Therefore, at the midpoint, the  $K_a$  of the weak acid can be easily calculated from the measured pH level.

At the equivalence point, just enough strong base has been added to completely react with all the weak acid. After the reaction, the only species present will be the conjugate base,  $A^-$ . Since  $A^-$  is a conjugate base, it will accept a proton from water to reform HA and  $OH^-$  in the equilibrium reaction shown by:

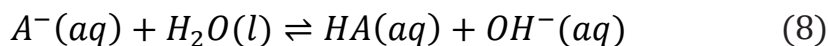

The equilibrium constant expression is given by:

$$K_b = \frac{[HA][OH^-]}{[A^-]} \quad (9)$$

## Acid Dissociation Constants and the Titration of a Weak Acid

The equilibrium constant,  $K_b$ , is called the **base dissociation constant**. Knowing the original amount of HA placed into the flask, measuring the pH, and making the assumption that the concentration of the  $\text{OH}^-$  is the same as the concentration of HA, you can determine the concentrations of all three of the species in this equilibrium constant expression.

The  $K_a$  of a weak acid and the  $K_b$  of the corresponding conjugate base are related to each other by the equilibrium constant,  $K_w$ .

$$K_w = K_a K_b \quad (10)$$

By subtraction, you should be able to calculate the concentration of  $\text{A}^-$  in solution. Finally, using the relationship shown by equation (10), you will be able to re-calculate the value of  $K_a$  for the weak acid.

Beyond the equivalence point in the titration, the strong base,  $\text{OH}^-$ , will be in excess. Here, the excess base determines the pH of the solution. The amount of  $\text{OH}^-$  formed from the equilibrium reaction shown by equation (8) is negligible. You will then plot all the pH measurements made in this experiment against the quantity of strong base added to form a pH titration curve.

In this experiment, you will be titrating the weak acid, acetic acid, with the strong base, sodium hydroxide. After you find the volume of strong base needed to reach the equivalence point of the titration, you will use this information to calculate the concentration of the original weak acid solution. You will calculate the acid dissociation constant,  $K_a$ , of acetic acid using several measured pH readings along the titration. You will also compare the titration curves of a strong acid titration and weak acid titration.

## Procedure

---

**Work in pairs** on this experiment.

Each student must collect data and submit a separate report.

The actual data analyses and the written reports must be done entirely independently of your lab partner or other students. Make sure that you avoid unauthorized collaboration and plagiarism. All suspected violations of the Code of Academic Conduct will be referred to Student Judicial Affairs.

### Preparation for Next Lab

---

Before starting the Weak Acid Titration experiment, each pair of students needs to dry a sample of solid sodium carbonate in preparation for next week's Polyprotic Acid experiment.

1. Fill one vial with approximately 1 g of anhydrous sodium carbonate.
2. Place the uncapped vial in your 100 mL beaker to keep the vial from spilling in the oven.
3. Dry the sample in the oven for 1.5 hours. Do not adjust the temperature on the oven. The temperature on the oven has been preset and will heat to the correct temperature when the door remains closed.
4. After removing your sample from the oven, let it cool until it is warm but safe to handle.
5. After the sample has cooled, carefully remove the vial from the beaker using a test tube clamp and place it in the center of the desiccator in your locker. If the lid of your desiccator can be removed easily, ask your TA for some vacuum grease to properly seal your desiccator.

### Stock Chemicals Used

Chemical	Maximum Amount Used
6 M Acetic Acid	< 10 mL
Thymolphthalein Indicator	Drops
pH Meter Calibration Buffer, pH 4 (red)	< 5 mL
pH Meter Calibration Buffer, pH 7 (yellow)	< 5 mL
pH Meter Calibration Buffer, pH 10 (blue)	< 5 mL
Sodium Carbonate, (s)	< 1 g

### Safety First

---

Remember to always wear gloves when handling all acids and bases.

**Wear your goggles!**

### Hint

---

Using  $M_1V_1=M_2V_2$ , calculate the volume of 6M acetic acid stock solution needed to prepare your dilute acetic acid solution.

### Safety First

---

Before inverting the NaOH bottle, make sure it is properly capped.

### Part I. Solution Preparation

1. Prepare 200 mL of approximately 0.05 M acetic acid solution from 6 M acetic acid.
  - a. Calculate the volume of stock solution required in this dilution.
  - b. Add the appropriate amount of 6 M acetic acid to approximately 150 mL of DI water in a 250 or 500 mL Erlenmeyer flask.
  - c. Add DI water to the flask until the solution level reaches 200 mL.
  - d. Mix well.
2. Find your 1 L bottle of your standardized NaOH from the previous experiment. Before opening the bottle of NaOH, carefully invert it several times to ensure that your solution is uniform.

### Part II. Weak Acid Strong Base Titration Curve

This experiment requires the use of a pH meter to measure the pH of various solutions. The pH meter and the accompanying electrode are both very expensive and fragile. Treat both pieces of equipment with great care.

### Care of pH meter and pH electrodes

---

- Keep the tip of the electrode submerged in solution at all times.
  - Never leave the electrode in deionized water.
  - When rinsing the electrode use a light stream of deionized water.
  - Be careful of the electrode when adding strong base or when stirring the solution.
  - After completing the experiment, **store the electrode in the storage solution provided**. Additional storage solution is available in the laboratory if needed.
- 

### Titration Set Up

1. Calibrate the pH meter.
  - a. The pH meter will need to be calibrated before starting the experiment. There is no need to recalibrate later during the experiment.
  - b. Dispense the pH 4.00, pH 7.00, and pH 10.00 buffers into the mini buffer bottles, taking care not to overfill.

Standardize the pH meter using the three buffer solutions following the procedure outlined in the Appendix of this manual, pH Meter Operating Instructions.

**Always** keep the pH electrode in the electrode storage solution when not in use.

### Lab Skill Tips

---

Use the mini buffer bottles to store the pH calibration buffer solutions.



2. Prepare your titrant.
  - a. Condition a 25 mL buret with your standardized NaOH solution. Remember to check that the stopcock is closed before filling a buret. While holding the buret at a safe level, use a beaker to pour in your sodium hydroxide solution.
  - b. After conditioning, fill the buret to above the zero mark with a beaker, place the buret in the clamp, and dispel any air bubbles from the stopcock. Record the initial buret reading to two decimal places, eg. 1.24 mL. **Remember to check that the stopcock is closed before filling a buret.**
3. Prepare your titration vessel.
  - a. Using a 10 mL volumetric pipet, accurately transfer 30.00 mL of 0.05 M acetic acid to a 150 mL beaker.
  - b. To this solution, add 3–5 drops of thymolphthalein indicator and carefully place a clean magnetic stir bar into the beaker, without splashing.
4. Complete the titration set-up:
  - a. Set up the stir plate underneath the buret containing the sodium hydroxide titrant.
  - b. Place the beaker containing your dilute acetic acid solution onto the stir plate.
  - c. Clamp the pH electrode in place below the level of the liquid in the beaker and away from the stir bar. Adjust the position of the buret tip so that it is inside the beaker, away from the side but with the stopcock at a convenient location for you to manipulate. Position the beaker so that the stir bar is somewhat displaced away from the center of the beaker to allow room for the pH electrode but make sure that the stir bar is above the center of the stir plate.

### Lab Skill Tips

---

Read the buret at or slightly below eye level. Do not hold your hands or lab manual behind the buret.

You can hold a sheet of colored paper behind the buret to read the meniscus clearly.

### The Titration

5. First, you will perform a quick titration to find the approximate end point.

To do so, you will add the titrant (0.2 M NaOH) in small increments, and recording the volume reading in the buret and the pH reading from the pH meter in your note book after each addition. Follow the instruction closely and add the titrant in the correct increments.

### Titration Hints

---

- **DO NOT** use your wash bottle to rinse down the sides of the beaker, as any added volume will change the pH readings and invalidate the titration curve data being collected.
  - Record your buret readings after the addition of each increment.
  - Allow time for the reaction vessel to become equilibrated and for the pH reading to become stabilized and then record the pH value in your notebook alongside the buret reading.
  - When collecting data, leave an empty column between the buret reading and the pH in which to place the volume of NaOH added (difference between present buret reading and initial buret reading).
- 
- a. Before adding any titrant, record the pH of the dilute acetic acid solution.
  - b. Carefully add NaOH in 1 mL increments to the beaker until  $\text{pH} > 11$ . Record the buret reading and the pH reading. Note any color changes that occur alongside your buret and pH readings in your notebook.
  - c. When you have completed this titration, transfer the solution in the titration flask to an 800 mL beaker.
6. Estimate the equivalence point and the midpoint by graphing pH vs. volume of NaOH added.
    - a. Convert your buret readings to volumes of NaOH added.
    - b. In your notebook, graph a titration curve by plotting the pH level on the **y-axis** and the volume of NaOH added on the **x-axis**.
    - c. Find the area of the graph where the change in pH is the greatest, in other words, where the slope is the highest. The equivalence point is in this region.
    - d. Consider the volumes of NaOH that bracket this region and estimate the volume of NaOH needed to reach the **equivalence** point.
    - e. Estimate the volume of NaOH needed to reach the **midpoint** of the titration.

7. Refill your burets with the appropriate solutions and prepare another sample to be titrated following the same set up procedures as the first titration.
8. Perform a precise titration to accurately determine the midpoint and the equivalence point.

To do so, you will add the titrant in **very** small increments before and after the estimated midpoint and equivalence point, while recording the volume reading in the buret and the pH reading from the pH meter in your note book after each addition. Follow the instruction closely and add the titrant in the correct increments.

- a. Before adding any titrant, record the pH of the dilute acetic acid solution.
  - b. Add 1 mL increments of NaOH until you are within **2 mL** of the midpoint. Record the buret volume reading and the pH reading after each addition.
  - c. Once you are within 2 mL of the estimated midpoint, add NaOH 2 drops at a time until you are 2 mL beyond the midpoint. Record the buret reading and the pH after each 2-drop addition.
  - d. Add 1 mL increments of NaOH until you are within 2 mL of the endpoint. Record the buret reading and the pH after each addition.
  - e. Once you are within 2 mL of the estimated end point, add NaOH 2 drops at a time until you are 2 mL beyond the estimated end point. Record the buret reading and the pH after each addition.
  - f. Add 1 mL increments of NaOH until  $\text{pH} > 11$ . Record the buret reading and the pH after each addition.
  - g. When you have completed this titration, pour the solution in the titration flask into an 800 mL beaker.
9. Perform another precise titration following the steps from 8a–g.

### **Lab Skill Tips**

---

Read the buret at or slightly below eye level. Do not hold your hands or lab manual behind the buret.

You can hold a sheet of colored paper behind the buret to read the meniscus clearly.

### Clean Up

- Tightly cap and store the standardized NaOH and HCl solutions for later use.
- Adjust the pH of the used solution before disposal.
  - Drain the remaining NaOH from the buret into the 800 mL beaker. Slowly and carefully add any remaining 0.05 M acetic acid to the beaker.
  - Slowly and carefully, add 1 g of sodium bicarbonate to the solution in the 800 mL beaker. Pour this solution into the sink with copious amount of water.
- Rinse the buret and return it to the correct storage cabinet.
- Store the pH electrode in the appropriate storage solution container.

- ▶ **Continue to SAVE your standardized 0.2 M HCl and 0.2 M NaOH. You will use these solutions for the next 2 experiments.**

## Data Analysis

---

### Part I

1. What volume of 6 M  $\text{HC}_2\text{H}_3\text{O}_2$  stock solution did you use to prepare the 200 mL of 0.1 M  $\text{HC}_2\text{H}_3\text{O}_2$ ? Show how you calculated this volume.

### Part II

2. How many trials did you perform to determine the titration curve for the neutralization of  $\text{HC}_2\text{H}_3\text{O}_2$  by NaOH?
3. Using a spreadsheet program such as Excel, enter the volume of NaOH added and corresponding pH levels and plot the pH level on the y-axis and the volume of NaOH added on the x-axis to obtain a titration curve for each set of trial data. Use these plots to estimate the position of the equivalence point (that volume of NaOH which is midway between the two nearly linear asymptotic regions at low pH and at high pH). What is your best estimate of the volume of NaOH required to reach the equivalence point for each of your titration curves?
4. Compare and contrast the shape and trends of this titration curve to the strong acid-strong base titration curve. At what pH, does the equivalence point occur for each of the graphs? How do the slopes of the titration curves compare?
5. As instructed in questions 8 & 9 of the “Strong Acid-Strong Base Titration” experiment, calculate the volumes and the forward difference approximations for the first and second derivatives using each set of trial data. Graph the approximations to the first and second derivatives vs. NaOH volumes as you did in the previous laboratory.

Check with your teaching assistant to see how they want the graphs turned in (i.e. by email or printed copies). Make sure your name is on each graph and that you have clearly titled and labeled the vertical and horizontal axes.

If you completed 3 trials, you will turn in graphs for the 2nd and 3rd trials (6 graphs total). You will still need to make graphs for the 1st trial to determine the endpoint and midpoint, but you **do not** need to turn in these graphs.

6. Using the combined representations of the derivative graphs developed in questions 4 and 5, estimate the volume of NaOH required to reach the equivalence point for each of your trials. You should be able to make this estimate to within 0.02 mL, e.g. 10.98 mL.
7. Using the initial volume of acetic acid, the volume of NaOH at the equivalence point and the standardized molarity of your NaOH, calculate the molarity of acetic acid you obtained in each of your trials. Then calculate the average value of the molarity of your acetic acid solution and use this value in all subsequent calculations where the molarity of the acetic acid solution is required.

## Acid Dissociation Constants and the Titration of a Weak Acid

- Average the value of the initial pH of your acetic acid solutions before any NaOH was added, and calculate the  $K_a$  of acetic acid based on your calculated average molarity and the average pH of the acetic acid solution before any sodium hydroxide was added.
- Find the pH of the midpoint for each of the trials using half the volume of NaOH required to reach the equivalence point for that trial. Use the sum of the initial volume and the volume of NaOH to reach the midpoint as the total solution volume at the midpoint. Combine these data with the pH at the midpoint to calculate  $K_a$  for each trial.
- Calculate the average  $K_a$  of acetic acid based on the pH at the midpoint from each of your trials.
- For each trial, calculate the  $K_a$  of acetic acid based on your calculated average molarity the initial volume of acetic acid, the volume of NaOH required to reach the equivalence point, and the pH of your acetic acid solution at the equivalence point. Then calculate the average value of  $K_a$  from the equivalence point determinations.
- Compare the rate of change of pH vs. volume of NaOH at the midpoint to the rate of change vs. volume of NaOH at the equivalence point on the weak acid titration curve. The rate of change of pH vs. volume is  $(\text{pH}_{(i)} - \text{pH}_{(i-1)}) / (V_{(i)} - V_{(i-1)})$ . Which is larger? Which pH has the greater uncertainty, the equivalence point pH or the midpoint pH?
- Calculate the concentrations of the acetic acid and the acetate ion at the midpoint.
- At what volume of NaOH did the indicator change color? Does this agree with the volume of NaOH needed to reach the equivalence point? What does this suggest to you about the selection of an indicator for an acid-base titration?
- Which solution would have a higher pH, 0.1 M HBr or 0.1 M  $\text{CH}_3\text{COOH}$ ? Explain.

### Conclusion.

Take a moment to reflect on the standardization of acetic acid and the titration curves, and then compose a summary paragraph that describes today's experiment and your new understanding of weak-acid titration reactions. How does the weak-acid titration curve differ from the strong-acid titration curve?

# Polyprotic Systems

## Introduction

---

Until now you have dealt primarily with monoprotic acids such as hydrochloric and nitric acid in the laboratory. This leaves an entire world of polyprotic acids unexplored. Polyprotic acids, acids that have more than one acidic proton, are common. For example, you have worked with sulfuric acid and with KHP that comes from diprotic phthalic acid.

In this experiment, you will trace out the entire titration curve of the diprotic acid, carbonic acid  $\text{H}_2\text{CO}_3$ . Carbonic acid is made by dissolving carbon dioxide  $\text{CO}_2$  in water. In addition to the environmental presence of carbonic acid formed by dissolving the  $\text{CO}_2$  from the air into water or by acidifying waters that have percolated through formations containing carbonate minerals, the carbonic acid system plays another major role in the respiration of all animals, including humans. The equilibrium among  $\text{CO}_2(g)$ ,  $\text{H}_2\text{O}(l)$ ,  $\text{HCO}_3^-(aq)$ , and  $\text{CO}_3^{2-}(aq)$  is critical for the proper transport of  $\text{CO}_2$ , formed in the metabolic cycle inside cells, through the blood stream to be expelled by the lungs. While carbonic acid is not a strong acid by the dissociation definition, it is corrosive and does react with metals to form carbonates.

In this experiment, we will start with  $\text{Na}_2\text{CO}_3$  and add acid, detecting the formation of each of the two endpoints of the titration curve using a pH meter. One aspect of polyprotic acids that is different from monoprotic acids is that they always make buffer solutions. Think about your list of strong acids: all except sulfuric acid are monoprotic acids, and only the first proton of sulfuric acid is considered strong. This buffering action can make experiments more complicated. In the experiment you are about to perform, titration of the first endpoint that you encounter establishes a buffer solution that complicates the analysis and determination of  $K_a$  for that equivalence point. We should note here that this buffering action can also be used to your benefit. Some reactions take place only in a specific pH range, and buffers can be used to maintain this pH during an experiment. You will be examining the nature of buffer solutions in the next experiment in the series on acid-base chemistry.

Polyprotic acids can generate very complex systems at equilibrium. For example, phosphoric acid undergoes three separate dissociations:

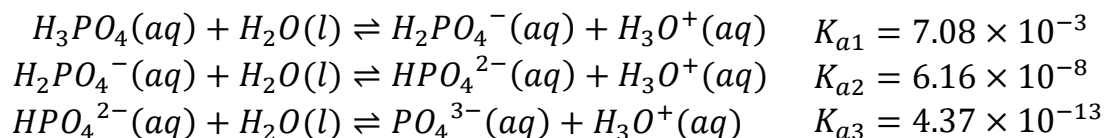

Each of these dissociations is an equilibrium reaction with an acid dissociation constant. As a result, calculating the concentrations of the species present in a phosphoric acid solution can become quite involved. Nevertheless, salts of phosphoric acid are commonly used for the preparation of buffer solutions in biochemical studies.

## Polyprotic Systems

The important acid-base reactions for carbonate are:

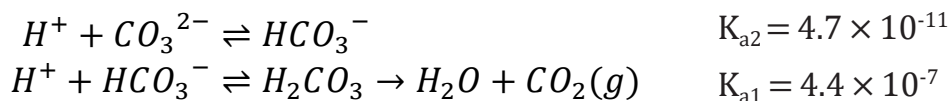

We have written the acid dissociation reactions in the reverse of the usual direction to emphasize that we are starting from a solution of  $Na_2CO_3$ . Also notice that during the titration you will encounter the equivalence point of the **second** proton ( $K_{a2}$ ) of diprotic carbonic acid as the first equivalence point in the titration. It occurs at high pH. The **first** proton ( $K_{a1}$ ) is encountered as the second equivalence point in the titration. It occurs at low pH. One of the goals of this experiment will be to make your own determinations of the two acid dissociation constants of carbonic acid.

Because of the polyprotic nature of carbonic acid, the equilibrium analysis necessary to develop the formulas for reduction of measurements of the pH into the acid dissociation constant are somewhat involved for the second proton equilibrium (the first equivalence point that you will encounter in the titration). We will not go through the details of the development, but will just describe for you how to find the final formulas. You may want to go through the development on your own, using the discussion as an aid to prove to yourself that the formulas are correct. At the second proton equivalence point, the solution is identical in composition with a solution of the sodium salt of the bicarbonate ion  $HCO_3^-$  (except for some extra dissolved  $NaCl(aq)$ ). An equilibrium treatment of the pH of that solution will yield precisely the formulas we need to work with. The dominant species equilibria to be considered are:

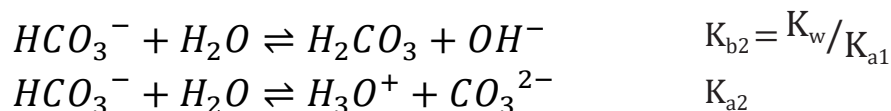

We start by writing down the two conditions that are commonly referred to as a mass balance and a charge balance. The mass balance sets the sum of all carbonate containing species equal to the total concentration in the original sample as diluted to the present volume. The charge balance sets the sum of the concentrations of all positively charged species equal to the sum of the concentrations of all the negatively charged species (including the sodium cation needed for  $NaHCO_3$ ). These two conditions are combined into an equality that must be observed.

We then use the two equilibrium expressions listed above and the  $K_w$  equilibrium to re-express  $[H_2CO_3]$ ,  $[CO_3^{2-}]$ , and  $[OH^-]$ , and insert these into the combined equality. The combined equality is then simplified and rearranged to get the result:

$$[H_3O^+] = \sqrt{\frac{K_{a2}[HCO_3^-] + K_w}{1 + \frac{[HCO_3^-]}{K_{a1}}}}$$



While this formula looks difficult to work with, the specific circumstances of the carbonic acid equivalence point simplify it greatly. Firstly, for convenient laboratory concentrations, and specifically, for those used in this experiment, it will be true that  $[\text{HCO}_3^-] \gg K_{a1}$ . Consequently, we may neglect the unity in the denominator.

Further, it will also be the case that  $K_{a2}[\text{HCO}_3^-] \gg K_w$ , so that  $K_w$  may be neglected in the numerator. Canceling and simplifying then gives:

$$[\text{H}_3\text{O}^+] = \sqrt{K_{a1}K_{a2}} \quad (1)$$

While this does not give us either of the acid constants directly, if we know one of them, we can use this relationship to determine the other.

From the equilibrium at the second equivalence point we get the necessary additional information that enables the determination of both acid dissociation constants. At the second equivalence point, the solution has had two equivalents of protons added to the analyte. For purposes of consideration of the pH equilibria, the solution is then simply that of carbonic acid  $\text{H}_2\text{CO}_3$  (with some extra NaCl in solution that does not affect the acid equilibria).

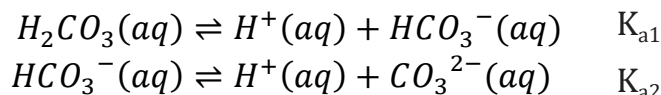

A fairly quick solution of these equilibria is available if  $K_{a1} \gg K_{a2}$  because then we may assume that the  $[\text{H}^+]$  concentration arises dominantly from the first equilibrium, and then  $[\text{H}^+] = [\text{HCO}_3^-]$ .

Writing the equilibrium constant expressions:

$$K_{a1} = \frac{[\text{H}^+][\text{HCO}_3^-]}{[\text{H}_2\text{CO}_3]}; \quad K_{a2} = \frac{[\text{H}^+][\text{CO}_3^{2-}]}{[\text{HCO}_3^-]}$$

Rearranging these expressions:

$$[\text{H}_2\text{CO}_3] = \frac{[\text{H}^+][\text{HCO}_3^-]}{K_{a1}}, \quad [\text{HCO}_3^-] = \frac{[\text{H}^+][\text{CO}_3^{2-}]}{K_{a2}}$$

Using substitution:

$$[\text{H}_2\text{CO}_3] = \frac{[\text{H}^+]^2[\text{CO}_3^{2-}]}{K_{a1}K_{a2}}$$

## Polyprotic Systems

Since  $[H^+] = [HCO_3^-]$ , solving for  $[CO_3^{2-}]$  in the previous expression gives:

$$[CO_3^{2-}] = \frac{[HCO_3^-]}{[H^+]} K_{a2} = K_{a2}$$

This reduces the expression for  $[H_2CO_3]$  to:

$$[H_2CO_3] = \frac{[H^+]^2}{K_{a1}}$$

Now in a solution that is M molar in  $H_2CO_3$ , we must have:

$$[HCO_3^-] + [CO_3^{2-}] + [H_2CO_3] = M$$

$$[H_2CO_3] = M - ([HCO_3^-] + [CO_3^{2-}])$$

Since we are dealing with weak acid dissociation constants, we can expect

$$[HCO_3^-] + [CO_3^{2-}] \ll M,$$

hence  $[H_2CO_3] = M$

Using the concentrations in the expression for  $K_{a1}$ ,

$$K_{a1} = \frac{[H^+]^2}{M} \quad (2)$$
$$[H^+] = \sqrt{MK_{a1}}$$

In the titration,  $M = \frac{a}{(V + v)}$ , where  $a = \frac{g}{105.99 \text{ g/mol}}$ , the number of moles of sodium carbonate in the sample,  $g$  = grams of  $NaCO_3$  in the titrated sample,  $V$  is the original volume of water in which the sample was dissolved, and  $v$  is the volume of HCl added to reach the second equivalence point in the titration. Of course in both equations (1) and (2),  $[H^+] = \text{antilog}_{10}(-\text{pH})$ . Once  $K_{a1}$  is found, equation (1) may be used to find  $K_{a2}$ .

**In preparation for the Acid-Base Buffer experiment, obtain your group number for your assigned pH values from your TA.**

Write your Group Number here: \_\_\_\_\_

## Procedure

---

**Work in pairs** throughout this experiment.

Each student must collect data and submit a separate report.

The actual data analyses and the written reports must be done entirely independently of your lab partner or other students. Make sure that you avoid unauthorized collaboration and plagiarism. All suspected violations of the Code of Academic Conduct will be referred to Student Judicial Affairs.

### Stock Chemicals Used

Chemical	Maximum Amount Used
Bromocresol Green Indicator	Drops
Phenolphthalein Indicator	Drops
pH Meter Calibration Buffer, pH 4 (red)	< 5 mL
pH Meter Calibration Buffer, pH 7 (yellow)	< 5 mL
pH Meter Calibration Buffer, pH 10 (blue)	< 5 mL
Sodium Carbonate, (s)	< 1 g

### Titration Set Up

- Prepare the sodium carbonate solution.
  - For this procedure, you will need dried sodium carbonate, which you have prepared and stored in a desiccator during the previous experiment.
  - Accurately weigh one sample of 0.10–0.15 g sodium carbonate by difference into a 150 mL beaker. Record the mass in your notebook.
  - Add 30 mL of precisely measured DI water to the titration vessel. Record the volume added to the nearest 0.02 mL. Make sure the sodium carbonate is **fully dissolved** before starting the titrations.
- Prepare the titrant.
  - Find your 1 L bottle of your standardized HCl from the previous experiments. Before opening the bottle, carefully invert it several times to ensure that your solution is uniform.
  - Condition a 25 mL buret with your standardized HCl solution. Remember to check that the stopcock is closed before filling a buret. While holding the buret at a safe level, use a beaker to pour in your hydrochloric acid solution.

### Safety First

---

Remember to always wear gloves and take caution when handling all acids and bases.

**Wear your goggles!**

### Safety First

---

Before inverting the HCl bottle, make sure it is properly capped.

- c. After conditioning, fill the buret to above the zero mark with a beaker, place the buret in the clamp, and dispel any air bubbles from the stopcock. Record the initial buret reading to two decimal places, e.g. 1.24 mL. **Remember to check that the stopcock is closed before filling the buret.**
3. Calibrate the pH meter.
    - a. The pH meter will need to be calibrated before starting the experiment. There is no need to recalibrate later during the experiment.
    - b. Dispense the pH 4.00, pH 7.00, and pH 10.00 buffers into the mini buffer bottles, taking care not to overfill. Standardize the pH meter using the three buffer solutions following the procedure outlined in the Appendix of this manual, pH Meter Operating Instructions.

### Care of pH meter and pH electrodes

- Keep the tip of the electrode submerged in solution at all times.
- Never leave the electrode in deionized water.
- When rinsing the electrode use a light stream of deionized water.
- Be careful of the electrode when adding strong base or when stirring the solution.
- After completing the experiment, STORE THE ELECTRODE IN THE STORAGE SOLUTION provided. Additional storage solution is available in the laboratory if needed.

- 
4. Complete the titration set-up:
    - a. Set up the stir plate underneath the buret containing the HCl titrant.
    - b. Place the titration vessel with your sodium carbonate solution onto the stir plate.
    - c. To the titration vessel, add 3–5 drops of phenolphthalein indicator.
    - d. Clamp the pH electrode in place below the level of the liquid in the beaker and away from the stir bar. Adjust the position of the buret tip so that it is inside the vessel, away from the side but with the stopcock at a convenient location for you to manipulate. Position the titration vessel so that the stir bar is somewhat displaced away from the center to allow room for the pH electrode but make sure that the stir bar is above the center of the stir plate.

## The Titrations

5. Perform the first titration.

To do so, you will add the titrant (0.2 M HCl) in small increments throughout the titration, and in very small increments before and after the estimated equivalence points. Follow the instruction closely and add the titrant in the correct increments. Record all relevant observations in your notebook.

Work efficiently by having one partner add the titrant and report the buret reading while the other read the pH meter and record the data. Make sure that each partner has a complete set of data after a complete titration is finished. Make sure the data for the sodium carbonate (including the mass of the sodium carbonate and volume of water added) are clearly recorded in your notebook.

### Titration Hints

- **DO NOT** use your wash bottle to rinse down the sides of the beaker, as any added volume will change the pH readings and invalidate the titration curve data being collected.
  - Only one person should be filling the buret. Make sure the stopcock is closed before filling.
  - Use a 100 or 150mL beaker to fill the buret. Never use flasks, 1L bottles, or larger beakers to fill the buret.
  - Record your buret readings after the addition of each increment.
  - Allow time for the reaction vessel to become equilibrated and for the pH reading to become stabilized and then record the pH value in your notebook alongside the buret reading.
  - When collecting data, leave an empty column between the buret reading and the pH in which to place the volume of NaOH added (difference between present buret reading and initial buret reading).
- 
- a. Turn on the magnetic stir bar slowly and increase the setting gradually until you have it rotating at a moderate speed.
  - b. Before adding any titrant, record the buret reading the pH of the analyte solution.
  - c. Add HCl in 1 mL increments until the pH reaches 9.6. Record the buret volume reading and the pH reading after each addition.
  - d. Once the pH reaches 9.6, add HCl in 0.10 mL increments until a **pH of 7 or lower** is reached. Record the buret reading and the pH after each addition.
    - i. The solution should turn clear within this pH interval. Record any color change you observe next to the corresponding pH reading.

### Lab Skill Tips

Read the buret at or slightly below eye level. Do not hold your hands or lab manual behind the buret.

You can hold a sheet of colored paper behind the buret to read the meniscus clearly.

- ii. After the solution turns clear, add 3–5 drops of bromocresol green indicator.
    - iii. Continue to add HCl in 0.10 mL increments until you have added a total of 1 mL of titrant **past the volume at which the solution turned clear**. Record the buret volume reading and the pH reading after each addition.
  - e. Add HCl in 1 mL increments until the pH reaches 5.5. Record the buret volume reading and the pH reading after each addition.
  - f. Once pH reaches 5.5, add HCl in 0.10 mL increments until you observe a color change. Record the buret reading and the pH after each addition. Record any color change you observe next to the pH reading.
  - g. After you observe the color change, continue adding HCl in 0.10 mL increments until you have added a total of 2 mL of titrant after the color change. Record the buret volume reading and the pH reading after each addition.
  - h. Add HCl in 1 mL increments you have added a total of 3 mL after the last step. Record the buret volume reading and the pH reading after each addition.
  - i. When you have completed this titration, pour the solution in the titration vessel into an 800 mL beaker.
6. You will now repeat the titration for the remaining two samples by repeating steps 1–5.
  - a. Exchange roles if you did not trade off during the first titration. Each partner needs to have performed all roles.
  - b. You should modify your technique for the remaining two samples based on your experience with the first one. You may find these general directions need to be slightly adjusted to improve the quality of data for your curve, for example by choosing a somewhat different specific pH at which to change the increment sizes.

### Lab Skill Tip

You do not need to calibrate the pH meter again after each titration.

**Clean Up**

- Tightly cap and store the bottles containing the standardized NaOH and HCl solutions for use in later experiments.
- Adjust the pH of the used solution before disposal.
  - Drain the remaining HCl from the buret into the 800 mL beaker.
  - Slowly and carefully, add your remaining sodium carbonate sample into the 800 mL beaker. Pour this solution into the sink with copious amount of water.
- Rinse the buret and return it to the correct storage cabinet.
- Store the pH electrode in the appropriate storage solution container.

- ▶ **Continue to SAVE your standardized 0.2 M HCl and 0.2 M NaOH. You will use these solutions for the next experiment.**

## Data Analysis

---

1. What are the precise masses of  $\text{Na}_2\text{CO}_3$  used for each of your three titration curves?
2. Prepare plots of your titration data and of the first and second divided differences as was described in the “Strong Acid-Strong Base Titration” experiment to help you more accurately determine the equivalence point. You may find it convenient to copy and modify the spreadsheet program you prepared to work up the data for that experiment and use it here.

A first divided difference curve is the graph of the change in pH divided by the change in volume ( $\Delta\text{pH}/\Delta V$ ) versus the volume added. It approximates the first derivative (rate of change of pH with volume).

A second divided difference curve is the graph of the change in  $\Delta\text{pH}/\Delta V$  versus volume or  $\Delta\Delta\text{pH}/\Delta V\Delta V$  versus volume. It approximates the second derivative (rate of change of the rate of change).

On the first divided difference curve, the equivalence point of the titration is the maximum point of the graph, and on the second divided difference curve, the equivalence point of the titration is where the graph passes through the horizontal axis.

Examples of these plots can be found at the end of the laboratory procedure description for the experiment “Strong Acid-Strong Base Titration”. From these plots, determine the volume of HCl required to reach the equivalence points in your titrations.

Check with your teaching assistant to see how they want the graphs turned in (i.e. by email or printed copies). Make sure your name is on each graph and that you have clearly, title and label the vertical and horizontal axes. If you completed 3 trials, you will turn in graphs for the 2nd and 3rd trials (6 graphs total). You will still need to make graphs for the 1st trial to determine the endpoint, but you **do not** need to turn in these graphs.

Using the same sequence in which you ordered the masses of  $\text{Na}_2\text{CO}_3$ , what are your best values for the volumes of HCl required to reach the first equivalence point in the titration (carbonic acid second proton equivalence point) for each of your three titration curves?

Again, in the same sequence, what are your best values for the volumes of HCl required to reach the second equivalence point in the titration (carbonic acid first proton equivalence point)?

3. Over what pH range did phenolphthalein change color? What was the color change?
4. Over what pH range did bromocresol green change color? What was the color change?



- Using the data for the second equivalence point (the equivalence point of the first proton dissociation from carbonic acid), use equation (2) of the introduction to this experiment to calculate  $K_{a1}$  from each of the three titration curves.

What are the three values of  $K_{a1}$  that you get from your curves? What is the standard deviation among them?

- Use the pH of the first equivalence point (the equivalence point of the second proton dissociation from carbonic acid), equation (1) of the introduction and the values of  $K_{a1}$  you determined in Question 5 to calculate  $K_{a2}$  for each of the three titration curves.

What are the three values of  $K_{a2}$  that you get from your curves? What is the standard deviation among them?

### **Conclusion.**

After reflecting on the nature of the titration curve for a diprotic acid, the difference from that of a monoprotic acid, and the complexity of analyzing the data from the titration curve to extract the values of the acid dissociation constants, compose a summary of this experiment. Include some comments about the sources of error in the experiment that may be responsible for the difference between the values you have obtained and the accepted literature values for the dissociation constants of carbonic acid.



# Acid-Base Buffers

## Introduction

---

In this experiment we will focus on the topic of acid-base buffers. An acid-base buffer is a solution that resists pH change. Buffers are very important in chemistry since many reactions will only occur in certain pH ranges. This is especially true of many biological systems in which the pH must be maintained in very narrow ranges if the organism is to survive.

Buffers are solutions that simultaneously contain relatively large amounts of acid/base conjugate pairs. An example that you are already familiar with is the acetic acid/acetate ion conjugate pair. A solution containing both of these substances will be a buffer because the weak acid will react with added base to produce the conjugate base via:

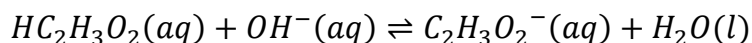

and the conjugate base present will react with added acid to produce the conjugate acid via:

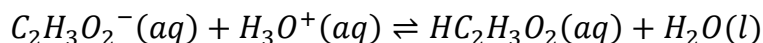

In both cases the pH will change with the addition of acid or base, however the pH will change very little if the amounts of added base or acid is small relative to the concentration of the buffer conjugates already present in the solution.

Additionally, a buffer works best when the pH is about the same as the  $pK_a$  for the acid component of the buffer. To illustrate this, consider the reaction:

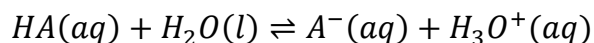

for which the  $K_a$  expression is:

$$K_a = \frac{[H_3O^+][A^-]}{[HA]}$$

## Acid-Base Buffers

If we take the  $-\log$  of both sides then we have,

$$-\log K_a = -\log[H_3O^+] - \log \frac{[A^-]}{[HA]}$$

or

$$pH = pK_a + \log \frac{[A^-]}{[HA]}$$

Considering the second term in the above equation, we see that in order for the pH change to be minimal, the contribution of the logarithm must be small. In fact, the logarithm will be zero if  $[A^-] = [HA]$  since  $\log 1 = 0$ . Therefore, as strong acids or bases are added, we can expect a buffer solution to work best at stabilizing the pH when  $[A^-] = [HA]$ . If the pH is the same as the  $pK_a$ , it follows that  $[A^-] = [HA]$ . The above equation can also be used to determine the conjugate acid-base concentrations required to make a buffer of specified pH. We can rearrange this equation to express the conjugate acid-base concentration ratio in terms of pH. We do this by subtracting  $pK_a$  from both sides of the equation then taking the antilog of both sides. Recall that the antilog function is  $10^x$ .

$$\frac{[A^-]}{[HA]} = 10^{(pH - pK_a)}$$

Given a target pH for the buffer and a desired concentration for either the conjugate acid or base, one can then find the concentration and thus a mass or volume required of the unspecified conjugate to complete the buffer solution.

Table 1 contains a list of useful  $pK_a$  values needed for this lab.

**Table 1.  $pK_a$  values for Acids used in the experiment**

<u>Name of Acid</u>	<u>Dissociation Reaction</u>	<u>pKa</u>
Acetic acid	$HC_2H_3O_2(aq) + H_2O(l) \rightleftharpoons H_3O^+(aq) + C_2H_3O_2^-(aq)$	4.74
Hydrogen carbonate ion	$HCO_3^-(aq) + H_2O(l) \rightleftharpoons H_3O^+(aq) + CO_3^{2-}(aq)$	10.33

In this experiment, you will prepare two buffers and study the effects of adding acid and base. For each of the buffers you will calculate the amounts of the conjugates required to prepare the buffer solutions. Then you will make small additions of acid and base to the buffer solutions and observe the pH changes that occur. You will graph these pH changes against volume and make comparisons to the previous experiments.

**As preparation for this experiment, study the section on Acid-Base Buffers in your textbook.**

## Pre-Lab Preparation

---

The calculations for this experiment are not trivial. For this reason, you are required to prepare for this experiment by calculating the needed amounts of your reagents to make your buffer solutions at the assigned pH values.

You should have been assigned a group number during the previous laboratory session. (You were asked to write it down in your lab manual immediately following the introduction of the Polyprotic System Experiment.)

Table 2 identifies the assigned pH values by group numbers. If you do not complete the calculations before the laboratory session, you may not have time to complete this experiment.

**Table 2. pH of Buffer Solutions**

	<b>Acidic Buffer</b>	<b>Basic Buffer</b>
<b>Group 1</b>	4.5	10.0
<b>Group 2</b>	4.6	10.1
<b>Group 3</b>	4.7	10.2
<b>Group 4</b>	4.8	10.3
<b>Group 5</b>	4.9	10.4
<b>Group 6</b>	5.0	10.5

You must have the calculations checked by the teaching assistant before you can begin the laboratory experiment.

## Procedure

---

**Work in pairs** for this experiment.

Each student must collect data and submit a separate report. The actual data analyses and the written reports must be done entirely independently of your lab partners or other students. Make sure that you avoid unauthorized collaboration and plagiarism. All suspected violations of the Code of Academic Conduct will be referred to Student Judicial Affairs.

### Safety First

Remember to always wear gloves and take caution when handling all acids and bases.

**Wear your goggles!**

### Stock Chemicals Used

Chemical	Maximum Amount Used
6 M Hydrochloric Acid	According to calculation (< 10 mL)
6 M Sodium Hydroxide	According to calculation (< 10 mL)
6 M Acetic Acid (CH <sub>3</sub> COOH)	According to calculation (< 30 mL)
2.5 M Sodium Acetate (NaCH <sub>3</sub> COO·3H <sub>2</sub> O)	According to calculation (< 25 mL)
Sodium Carbonate (Na <sub>2</sub> CO <sub>3</sub> )	According to calculation (< 5 g)
Sodium Bicarbonate (NaHCO <sub>3</sub> )	According to calculation (< 5 g)
pH Meter Calibration Buffer, pH 4 (red)	< 5 mL
pH Meter Calibration Buffer, pH 7 (yellow)	< 5 mL
pH Meter Calibration Buffer, pH 10 (blue)	< 5 mL

### Part I. Preparing Your Buffers

You will be cooperating with another group of students to prepare two 250 mL buffer solutions, an acidic and a basic buffer. Divide the tasks amongst yourselves so that each group receives approximately 120 mL of the correct acidic buffer and 120 mL of the basic buffer at the end of Part I.

The acidic buffer will be prepared from a 6 M acetic acid (CH<sub>3</sub>COOH) solution and 2.5 M sodium acetate trihydrate (NaCH<sub>3</sub>COO·3H<sub>2</sub>O). The basic buffer solution is prepared from solid sodium hydrogen carbonate (NaHCO<sub>3</sub>) and solid anhydrous sodium carbonate (Na<sub>2</sub>CO<sub>3</sub>). After preparing the solutions you will measure the pH level of the solution and adjust the levels by adding either strong acid or strong base as needed.

1. **Group Member Assignments:** During the previous laboratory experiment, the TA assigned your group a number between **1 and 6**. Work with the other group with the **same buffer assignment** to prepare the 2 buffer solutions at the designated pH values given in Table 2.

Have one group prepare the 250 mL of the acidic buffer and the other group prepare 250 mL of the basic buffer at the designated pH values.

2. Preparation of Acidic Buffer in a 250 mL volumetric flask:
  - a. Calculate the volume of 2.5 M sodium acetate solution needed to prepare 250 mL of 0.10 M sodium acetate. The 2.5 M sodium acetate is in the fume hood; DO NOT USE the 1.0 M sodium acetate from the bench next to the fume hoods.
  - b. First, transfer approximately 15 mL of the 2.5 M sodium acetate solution into a small beaker, and then use a volumetric pipet to transfer the appropriate volume—calculated from the previous step—to your 250 mL volumetric flask. Add 120–150 mL of deionized water to the 250 mL volumetric flask and mix.
  - c. Calculate the volume of 6 M stock acetic acid solution you need to make 250 mL of the buffer solution to the designated pH.
  - d. Use your graduated cylinder to transfer this volume of 6 M acetic acid to the volumetric flask. Using a water bottle, fill the flask to the mark with deionized water to make a solution totaling 250 mL.
  - e. Mix the solution well, then transfer the solution to an appropriately 400 mL beaker.
3. Preparation of Basic Buffer in a 250 mL volumetric flask:
  - a. Calculate the mass of solid sodium hydrogen carbonate needed to prepare 250 mL of 0.050 M sodium hydrogen carbonate solution.
  - b. Weigh out this mass of solid sodium hydrogen carbonate and quantitatively transfer it to a clean 250 mL volumetric flask. Add 120–150 mL of deionized water to the 250 mL volumetric flask and mix.
  - c. Calculate the mass of solid anhydrous sodium carbonate required to make the basic buffer to the designated pH.
  - d. Weigh out this mass of anhydrous sodium carbonate and quantitatively transfer it to your 250 mL volumetric flask. Now, fill your flask to the mark with deionized water to make a solution totaling 250 mL. After you have mixed the buffer solution well, place the buffer solution into a clean and appropriately labeled 400 mL beaker.

### Hint

---

Using  $M_1V_1=M_2V_2$ , calculate the volume of 2.5M sodium acetate solution needed to prepare your dilute sodium acetate solution.

4. You will need to calibrate the pH meter at this point.
  - a. The pH meter will need to be calibrated before starting the experiment. There is no need to recalibrate later during the experiment.
  - b. Dispense the pH 4.00, pH 7.00, and pH 10.00 buffers into the mini buffer bottles, taking care not to overfill. Standardize the pH meter using the three buffer solutions following the procedure outlined in the Appendix of this manual, pH Meter Operating Instructions.

### Care of pH meter and pH electrodes

- Keep the tip of the electrode submerged in solution at all times.
- Never leave the electrode in deionized water.
- When rinsing the electrode use a light stream of deionized water.
- Be careful of the electrode when adding strong base or when stirring the solution.
- After completing the experiment, **store the electrode in the storage solution provided**. Additional storage solution is available in the laboratory if needed.

- 
5. Adjusting the pH of your buffer.

Your buffer solution may not be at the assigned pH. Use drop-wise addition of 6 M HCl or 6 M NaOH to adjust the pH.

- a. Measure the pH of your buffer.
- b. Using a disposable pipet, add 6 M HCl drop-wise to lower the pH, or add 6 M NaOH drop-wise to raise the pH.
- c. Adjust the pH until it is equal to the assigned pH. Stir the solution and record the pH to the nearest 0.02 pH unit.
- d. Split the buffer between the groups. Carefully pour the buffers into four labeled 250 mL Erlenmeyer flasks. Make sure that each group has at least **80 mL** of the acidic or basic buffer.



**Part II. Preparing Your Reagents**

1. Find your 1 L bottle of your standardized HCl from the previous experiments. Before opening the bottle, carefully invert it several times to ensure that your solution is uniform.
2. Find your 1 L bottle of your standardized NaOH from the previous experiments. Before opening the bottle, carefully invert it several times to ensure that your solution is uniform.
3. Prepare 120 mL of 0.1 M acetic acid from the 6 M acetic acid stock solution using a 150 mL beaker. Once the solution has been made, transfer it to a 125 mL, 250 mL, or 500 mL Erlenmeyer flask for storage and label the Erlenmeyer flask with a graphite pencil.
4. Condition and fill two 25 mL burets, one with the 0.2 M HCl solution and the other buret with 0.2 M NaOH. Record the initial volume of HCl and NaOH to the nearest 0.02 mL.

**Titration Hints**

---

- Be careful when filling the buret. Only one person should be filling the buret. Be sure the stopcock is closed before filling.
  - Use a 100 or 150 mL beaker to fill the buret. Never use flasks, 1 L plastic bottles, or large beakers to fill the buret.
- 

**Safety First**

---

Before inverting the HCl and NaOH bottles, make sure they are properly capped.

### Part III. Titration with 0.2 M HCl

In this part of the experiment, each group will treat each of the two buffer solutions with 0.2 M HCl solution. You will add the titrant (0.2 M HCl) in small increments throughout the titration. You will then plot the pH vs. added volume of HCl to graphically observe the pH changes that occur. You will also explore the effect of adding 0.2 M HCl to 0.1 M acetic acid solution.

#### Titration Hints

---

- **DO NOT** use your wash bottle to rinse down the sides of the beaker, as any added volume will change the pH readings and invalidate the titration curve data being collected.
  - Record your buret readings after the addition of each increment.
  - Allow time for the reaction vessel to become equilibrated and for the pH reading to become stabilized and then record the pH value in your notebook alongside the buret reading.
- 

1. Titrate the acidic buffer with 0.2 M HCl.
  - a. Place 40 mL of the acidic buffer in a clean 150 mL beaker. Gently, place a stir bar into the beaker.
  - b. Set up the beaker containing the buffer, stir plate, electrode under the buret containing the 0.2 M HCl solution. Start gently rotating the stir bar. Record the initial buret reading and pH meter reading.
  - c. Add HCl in 1 mL increments to the buffer until the pH of the buffer has decreased by 1.5 pH units. Record the buret reading and the pH reading after each addition.
  - d. **Save this solution** in an Erlenmeyer flask for use in the last part of this experiment.

2. Titrate the basic buffer with 0.2 M HCl.
  - a. Place 40 mL of the basic buffer in a clean 150 mL beaker. Gently, place a stir bar into the beaker.
  - b. Set up the beaker containing the buffer, stir plate, electrode under the buret containing the 0.2 M HCl solution. Start gently rotating the stir bar. Record the initial buret reading and pH meter reading.
  - c. Add HCl in 1 mL increments to the buffer until the pH of the buffer has decreased by 1.5 pH units. Record the buret reading and the pH reading after each addition.
  - d. When you have completed this titration, pour the solution in the titration vessel into an 800 mL beaker.
3. Titrate the 0.1 M acetic acid with 0.2 M HCl.
  - a. Place 40 mL of the 0.1 M acetic acid in a clean 150 mL beaker. Gently, place a stir bar into the beaker.
  - b. Set up the beaker containing the acetic acid solution, stir plate, electrode under the buret containing the 0.2 M HCl solution. Start gently rotating the stir bar. Record the initial buret reading and pH meter reading.
  - c. Add HCl in 1 mL increments to the buffer until the pH of the solution has decreased by 1.5 pH units. Record the buret reading and the pH reading after each addition.
  - d. When you have completed this titration, pour the solution in the titration vessel into an 800 mL beaker.

**Lab Skill Tips**

---

Read the buret at or slightly below eye level. Do not hold your hands or lab manual behind the buret.

You can hold a sheet of colored paper behind the buret to read the meniscus clearly.

### Part IV. Titration with 0.2 M NaOH

In this part of the experiment each group will treat each of the two buffer solutions with 0.2 M NaOH solution. You will add the titrant (0.2 M NaOH) in small increments throughout the titration. You will then plot the pH vs. added volume of NaOH to graphically observe the pH changes that occur. You will also explore the effect of adding 0.2 M NaOH to 0.1 M acetic acid solution.

1. Titrate the acidic buffer with 0.2 M NaOH.
  - a. Place 40 mL of the acidic buffer in a clean 150 mL beaker. Gently, place a stir bar into the beaker.
  - b. Set up the beaker containing the buffer, stir plate, electrode under the buret containing the 0.2 M NaOH solution. Start gently rotating the stir bar. Record the initial buret reading and pH meter reading.
  - c. Add NaOH in 1 mL increments to the buffer until the pH of the buffer has increased by 1.5 pH units. Record the buret reading and the pH reading after each addition.
  - d. When you have completed this titration, pour the solution in the titration vessel into an 800 mL beaker.
2. Titrate the basic buffer with 0.2 M NaOH.
  - a. Place 40 mL of the basic buffer in a clean 150 mL beaker. Gently, place a stir bar into the beaker.
  - b. Set up the beaker containing the buffer, stir plate, electrode under the buret containing the 0.2 M NaOH solution. Start gently rotating the stir bar. Record the initial buret reading and pH meter reading.
  - c. Add NaOH in 1 mL increments to the buffer until the pH of the buffer has increased by 1.5 pH units. Record the buret reading and the pH reading after each addition.
  - d. When you have completed this titration, pour the solution in the titration vessel into an 800 mL beaker.

3. Titrate the 0.1 M acetic acid with 0.2 M NaOH.
  - a. Place 40 mL of the 0.1 M acetic acid in a clean 150 mL beaker. Gently, place a stir bar into the beaker.
  - b. Set up the beaker containing the acetic acid solution, stir plate, electrode under the buret containing the 0.2 M NaOH solution. Start gently rotating the stir bar. Record the initial buret reading and pH meter reading.
  - c. Add NaOH in 1 mL increments to the buffer until the pH of the solution has increased by 1.5 pH units. Record the buret reading and the pH reading after each addition.
  - d. When you have completed this titration, pour the solution in the titration vessel into an 800 mL beaker.
4. Titrate your acetic acid buffer with HCl added with 0.2 M NaOH.
  - a. Transfer the acidic buffer and HCl mixture from step 11 to a clean 150 mL beaker.
  - b. Set up the beaker containing, stir plate, electrode under the buret containing the 0.2 M NaOH solution. Start gently rotating the stir bar. Record the initial buret reading and pH meter reading.
  - c. Add NaOH in 1 mL increments to the buffer until the pH of the solution has increased by 3.0 pH units. Record the buret reading and the pH reading after each addition.
  - d. When you have completed this titration, dispose of this solution down the sink with copious amount of water.

#### Clean Up

- Adjust the pH of the used solution before disposal.
  - To your 800 mL beaker, add 1 gram of sodium bicarbonate. Pour the solution down the sink with copious amount of water.
  - Consolidate the left over HCl, NaOH, acetic acid, and the buffer solutions in a 1 L bottle. Add 3 grams of sodium bicarbonate. Pour the solution in the sink with copious amount of water.
- Rinse the buret and return it to the correct storage cabinet.
- Store the pH electrode in the appropriate storage solution container.

## Data Analysis

---

### Part I.

1. What was your assigned pH value of your acidic buffer?
2. What volume of 2.5 M sodium acetate was needed to make 250 mL of the acetic acid/acetate ion buffer that has an acetate ion concentration of 0.20 M at that pH? Show your calculations.
3. What was the concentration of the acetic acid in the 250 mL acetic acid/acetate ion buffer solution at your assigned pH?
4. What volume of the 6 M acetic acid solution was needed to prepare the 250 mL acetic acid/acetate ion buffer solution?
5. What was your assigned pH value of your basic buffer?
6. What mass of sodium hydrogen carbonate was needed to make the buffer solution 0.1 M in sodium hydrogen carbonate? Show your calculations.
7. What was the concentration of the sodium carbonate in the hydrogen carbonate ion/ carbonate ion buffer solution? Show your calculations.
8. What mass of anhydrous sodium carbonate was required to make the 250 mL hydrogen carbonate ion/carbonate ion buffer at that pH? Show your calculations.
9. Provide reasons as to why the measured pH level is different from the calculated value.

### Part II.

10. What volume of the 6 M HCl stock solution is needed to prepare 250 mL of 0.2 M HCl? Show your calculation.
11. What volume of the 6 M NaOH stock solution is needed to prepare 250 mL of 0.2 M NaOH?

### Part III.

12. Using a spreadsheet program, such as Excel, make the following graphs.
  - a. Plot pH vs. added volume of HCl for both buffer solutions and the 0.2 M acetic acid solution. You should have 3 separate graphs when you are finished. Label each graph appropriately.
  - b. Plot pH vs. added volume of NaOH for both buffer solutions and the 0.2 M acetic acid solution. You should have 3 separate graphs when you are finished. Label each graph appropriately.
  - c. Plot pH vs. added volume of NaOH for the acetic acid/acetate ion buffer and HCl mixture used in step 8 of Part IV. Label the graph appropriately.

13. Let's compare the corresponding graphs. First, take the two graphs of the acidic acid buffer. Line up these two graphs along the pH axis (y-axis) and the volume axis (x-axis). One graph will be on top of the other. Flip the top graph  $180^\circ$ , keeping the pH axis aligned. After the flip, the volume axis will be lined up end-to-end. You should now have a curve that looks like an "S" laying on its side and one of the graphs will be face down. Hopefully your graph paper is "see through." What is the pH range over which the buffer effectively neutralizes the added acid and base and maintains a reasonably constant pH? This is referred to as the buffer range.
14. Compare the acidic buffer graph constructed in question 17 to the graph you made in question 16c. What are the differences, if any? How do the buffer ranges compare?
15. Repeat the procedure described in question 17 for graphs involving the basic buffer. What is the buffer range for the basic buffer?
16. Considering the ranges of pH of each buffer, write an equation in terms pH and  $pK_a$  that defines buffer range.
17. Buffer capacity is defined as the amount of acid or base that can be added to a buffer before any substantial change in pH. When is the buffer capacity at its maximum?
18. Repeat the procedure described in question 17 for the graphs involving the 0.2 M acetic acid solution. How do these graphs compare to the graphs of the acetic acid/acetate ion buffer? For example, compare the slopes of the curve of each graph at corresponding points. At corresponding pH values, compare how much HCl or NaOH is added before  $\Delta pH = 1$ .
19. Consider the titration curve you plotted for the "Titration of a Weak Acid" experiment. How does the titration curve compare to the graph involving the acetic acid/acetate ion buffer in this experiment? Does the titration curve include a buffer region? If so, where is the buffer region? If not, why not?
20. Check with your teaching assistant to see how they want the graphs turned in (i.e. by email or printed copies). Make sure your name is on each graph and that you have clearly, title and label the vertical and horizontal axes. You will turn in 7 total graphs.

**Conclusion.**

After reflecting on the nature of buffer solutions and their effectiveness over different pH ranges, compose a summary of this experiment.





# Solubility Products

## Introduction

---

The **solubility product constant**,  $K_{sp}$ , is the equilibrium constant for a process when an ionic solid substance dissolves into an aqueous solution at a given temperature. This experiment involves the determination of the  $K_{sp}$  for calcium iodate. The calcium iodate chemical system to be analyzed is described by the reaction

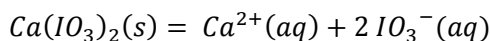

with a solubility product of

$$K_{sp} = [Ca^{2+}][IO_3^-]^2$$

In the first part of the experiment, you will determine the solubility of calcium iodate in pure water. The solubility,  $s$ , of the calcium iodate will be equal to the concentration of the calcium ion since for every mole of calcium iodate that dissolves, one mole of calcium ion forms.

Recall that the iodate ion concentration will be twice the calcium ion concentration in solution. Thus, if you can obtain the concentration of one ion you can calculate the concentration of the other ion. With the two concentrations, you can easily calculate the solubility product constant.

During Part I, you will determine the concentration of the iodate ion via what is known as an iodometric titration. In this process you will add excess iodide ion to a solution that is known to contain iodate ion in the presence of acid. The iodate reacts with the iodide by the following reaction:

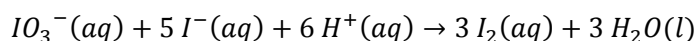

The  $I_2$  thus produced will then react via a titration with thiosulfate by the reaction:

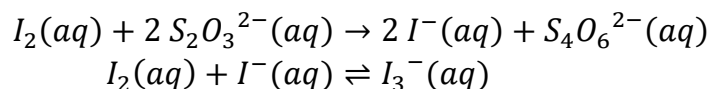

It should be noted that the progress of the latter reaction can be followed because the iodine formed reacts with the excess iodide ion to form the triiodide ion,  $I_3^-$ . The presence of this species is easily observed by its reaction with starch indicator to form a deep blue complex. Thus, in the presence of starch, the endpoint of this latter titration is when the deep blue color disappears. Once the concentration of the iodate has been determined, you can easily calculate the concentration of the calcium ion and then the  $K_{sp}$  for the system.

## Solubility Products

In the second part of this experiment, you will be able to observe the “common ion effect”. In this part of the experiment you will be given a saturated solution of calcium iodate in a 0.01 M potassium iodate solution. Once you determine the concentration of iodate by the method described above, you will be able to calculate the concentration of iodate from the dissolution of the calcium iodate and thus calculate the concentration of calcium ion in solution.

Using the concentration of the two ions, you will be able to calculate the solubility product constant for this system. By comparing the two parts, you will note the dramatic effect that the iodate ion from the potassium iodate has on the solubility of calcium iodate. Lastly, as part of the data workup of this experiment, you will incorporate activity effects in the calculation of the solubility product from your data. The correct incorporation of activity effects makes the treatment of equilibria and equilibrium constants more rigorous.

You have discussed some of the effects of the polarity of water, including the effect that polarity can have on the solubility of solids. It should not be surprising to find that water interacts with various ions differently and that a more highly charged particle has a greater interaction with water molecules. The higher the charge on an ion in solution, the greater will be the interaction of the ion with the dipole of the water molecule and with other ions in the solution. These interactions can be significant enough that they cannot be ignored when salt concentrations exceed hundredth molar values.

Equilibrium constants are properly defined in terms of thermodynamic activity rather than concentration. The thermodynamic activity is a function of concentration, but is not necessarily equal to the concentration. However, it is true that in the limit of extremely dilute solutions, the activity is equal to the concentration. Because the equilibrium constant expressions using concentrations in place of activity are rigorously correct in the limit of dilute concentration, they are conceptually parallel with the use of activities. Because the results are useful, if not exactly correct, we commonly discuss equilibria and equilibrium constants using the concentrations. In this experiment, however, we will recognize that the true expressions are in terms of activities.

Based on the equilibrium constant of  $1.3 \times 10^{-18}$  for the dissolution of mercury(I) iodate, you would expect a saturated solution of the salt to be  $6.9 \times 10^{-7}$  M in mercury(I) ion.

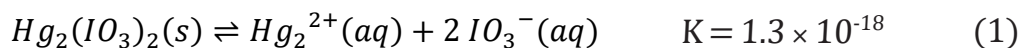

$$K = [\text{Hg}_2^{2+}][\text{IO}_3^-]^2 = s(2s)^2 \quad (2)$$
$$s = [\text{Hg}_2^{2+}] = 6.9 \times 10^{-7} M$$

So far, when you have determined the effect of other dissolved ions on a specific equilibrium, you have only considered the common ion effect. Based on this reasoning, you would not predict that potassium nitrate in solution would have any effect on the solubility of mercury(I) iodate. However, if you were to saturate a 0.05 M potassium nitrate with mercury(I) iodate you would find that the solubility of the mercury(I) iodate has increased by about fifty percent.

This turns out to be a general observation; any time you add an inert soluble salt to a solution of a sparingly soluble salt you will increase the solubility of the sparingly soluble salt.

The explanation for the observed increase in solubility is that the positively charged potassium ions can cluster around the negatively charged iodate ions, and the negatively charged nitrate ions cluster around the positively charged mercury(I) ions. When a mercury(I) ion comes close to an iodate ion surrounded by potassium ions, the positive charge on the potassium ions will repel the positive charge on the mercury(I) ion, preventing it from combining with the iodate ion and precipitating out of solution. Thus the mercury(I) iodate becomes more soluble.

The definition of the equilibrium constant represented in equation (2) above does not take this phenomenon into account. Instead of looking only at the concentration of a species in solution, the activity of that species should be also examined when equilibrium is considered. The activity of an ion includes both concentration and how susceptible the ion is to the kinds of effects described in the preceding paragraph. To incorporate these and other effects arising from molecular and ionic interactions in solution, we simply use the activity of the ion in place of the concentration in the equilibrium constant expression.

The general way for incorporating activities into equilibrium constants for the general reaction

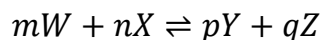

is to form the equilibrium constant in the usual way, but employing activity in positions in the equation where you were previously using concentration:

$$K = \frac{a_Y^p a_Z^q}{a_W^m a_X^n}$$

Following this procedure for our example solubility problem, equation (2) becomes:

$$K = a_{\text{Hg}_2^{2+}} + a_{\text{IO}_3^-}^2 \quad (3)$$

A convenient way to quantitatively account for the molecular interaction part of the activity is to express the activity as the product of an activity coefficient times the concentration. For example, the mercury iodate equilibrium requires the activities

$$\begin{aligned} a_{\text{Hg}_2^{2+}} &= \gamma_{\text{Hg}_2^{2+}} [\text{Hg}_2^{2+}] \\ a_{\text{IO}_3^-} &= \gamma_{\text{IO}_3^-} [\text{IO}_3^-] \end{aligned}$$

where  $\gamma_{\text{Hg}_2^{2+}}$  and  $\gamma_{\text{IO}_3^-}$  are the activity coefficients for  $\text{Hg}_2^{2+}$  and  $\text{IO}_3^-$ . Substituting these expressions into equation (3):

$$K = \left( \gamma_{\text{Hg}_2^{2+}} [\text{Hg}_2^{2+}] \right) \left( \gamma_{\text{IO}_3^-} [\text{IO}_3^-] \right)^2 = \gamma_{\text{Hg}_2^{2+}} \cdot \gamma_{\text{IO}_3^-}^2 [\text{Hg}_2^{2+}] [\text{IO}_3^-]^2$$

## Solubility Products

From this form, we can see that expressing the equilibrium constant using concentrations alone is identical to assuming that the activity coefficients are equal to 1.0. This assumption is also called the **ideal solution approximation**.

Because it is impossible to get a solution containing just the cation or just the anion, it is impossible to experimentally determine  $\gamma_{\text{Hg}_2^{2+}}$  and  $\gamma_{\text{IO}_3^-}$  individually. Instead their product is replaced by  $\gamma_{\pm}$ , the **mean ionic activity coefficient**, raised to the power equal to the sum of the exponents of the individual ion activity coefficients.

$$K = \gamma_{\pm}^3 [\text{Hg}_2^{2+}] [\text{IO}_3^-]^2$$

Since they account for molecular and ionic interactions, the values of activity coefficients change as the concentration of the solution changes. It has been found that a convenient quantity to use when expressing the functional dependence of the activity coefficients of ions on concentration is the ionic strength of the solution, which is defined by the expression:

$$\mu = \frac{1}{2} \sum_i c_i Z_i^2$$

where  $c_i$  is the concentration of the  $i$ th species and  $Z_i$  is its signed charge in multiples of the elementary charge, e.g.  $Z_{\text{Hg}_2^{2+}} = +2$  and  $Z_{\text{IO}_3^-} = -1$ . This sum extends over all ions in solution.

In this example, when contrasting the solubility of mercury(I) iodate in pure water and in 0.05 M potassium nitrate, it becomes very clear that the ionic strength of the solution in pure water is vastly different from the solution in 0.05 M potassium nitrate when we apply this definition,

$$\text{In pure water:} \quad \mu = \frac{1}{2} (4[\text{Hg}_2^{2+}] + [\text{IO}_3^-])$$

since  $\text{Hg}_2^{2+}$  and  $\text{IO}_3^-$  are the only ions in solution. However, in the solution containing potassium nitrate,

$$\mu = \frac{1}{2} (4[\text{Hg}_2^{2+}] + [\text{IO}_3^-] + [\text{K}^+] + [\text{NO}_3^-])$$

Because mercury(I) iodate is so sparingly soluble, calculations will give the result that in pure water,  $\mu = 0.0$ , whereas in 0.05 M potassium nitrate,  $\mu = 0.05$ .

While it is impossible to experimentally determine the values of individual ion activity coefficients, various theoretical and empirical methods for consistently separating the observed mean ionic activity coefficients into individual ion coefficients have been developed. These methods are by no means perfect, but they often give much better results than the alternative very simple assumption that the solutions are ideal. **Table 1.** presents results for one such method of representing individual ion coefficients as a function of the ionic strength of the solution.

**Table 1. Activity Coefficients for Aqueous Solution at 25°C**

<u>Ion</u>	<u>Ionic Strength (<math>\mu</math>, M)</u>					
	<u>0.001</u>	<u>0.005</u>	<u>0.01</u>	<u>0.05</u>	<u>0.1</u>	<u>0.15</u>
H <sup>+</sup>	0.967	0.933	0.914	0.86	0.83	0.81
Li <sup>+</sup>	0.965	0.929	0.907	0.835	0.80	0.77
Na <sup>+</sup> , IO <sub>3</sub> <sup>-</sup> , HCO <sub>3</sub> <sup>-</sup> , H <sub>2</sub> PO <sub>4</sub> <sup>-</sup>	0.964	0.928	0.902	0.82	0.775	0.76
OH <sup>-</sup> , F <sup>-</sup> , SCN <sup>-</sup> , MnO <sub>4</sub> <sup>-</sup> , ClO <sub>4</sub> <sup>-</sup>	0.964	0.926	0.900	0.81	0.76	0.73
K <sup>+</sup> , Cl <sup>-</sup> , Br <sup>-</sup> , I <sup>-</sup> , CN <sup>-</sup> , NO <sub>3</sub> <sup>-</sup>	0.964	0.925	0.899	0.805	0.755	0.72
Rb <sup>+</sup> , Cs <sup>+</sup> , NH <sub>4</sub> <sup>+</sup> , Ag <sup>+</sup>	0.964	0.924	0.898	0.80	0.75	0.71
Mg <sup>2+</sup> , Be <sup>2+</sup>	0.872	0.755	0.69	0.52	0.45	0.41
Ca <sup>2+</sup> , Cu <sup>2+</sup> , Zn <sup>2+</sup> , Mn <sup>2+</sup>	0.870	0.749	0.675	0.485	0.405	0.36
Sr <sup>2+</sup> , Ba <sup>2+</sup> , Cd <sup>2+</sup> , Hg <sup>2+</sup> , S <sup>2-</sup>	0.868	0.744	0.67	0.465	0.38	0.33
Pb <sup>2+</sup> , CO <sub>3</sub> <sup>2-</sup> , SO <sub>3</sub> <sup>2-</sup>	0.867	0.742	0.665	0.455	0.37	0.31
Hg <sub>2</sub> <sup>2+</sup> , SO <sub>4</sub> <sup>2-</sup> , CrO <sub>4</sub> <sup>2-</sup> , HPO <sub>4</sub> <sup>2-</sup>	0.867	0.740	0.660	0.445	0.355	0.30
Al <sup>3+</sup> , Fe <sup>3+</sup> , Cr <sup>3+</sup>	0.738	0.54	0.445	0.245	0.18	0.15
PO <sub>4</sub> <sup>3-</sup>	0.725	0.505	0.395	0.16	0.095	0.066
Sn <sup>4+</sup>	0.588	0.35	0.255	0.10	0.065	0.048

Source: Data from J. Kielland, *J. Amer. Chem. Soc.*, **59**, 1675 (1937)

As an example of how to use activities, here is a calculation of the concentration of calcium ion in a 0.0125 M solution of magnesium sulfate MgSO<sub>4</sub> saturated with calcium fluoride CaF<sub>2</sub>. The concentration of calcium is going to depend on how much calcium fluoride dissolves, so the chemical equilibrium and initial set-up of interest is

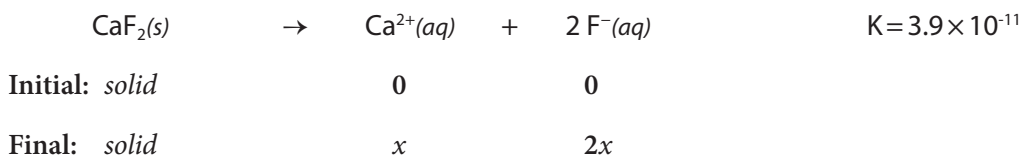

$$\begin{aligned}
 K &= (a_{Ca^{2+}})(a_{F^-}^2) \\
 &= (\gamma_{Ca^{2+}}[Ca^{2+}])(\gamma_{F^-}^2[F^-]^2) \\
 &= (\gamma_{Ca^{2+}}[x])(\gamma_{F^-}^2[2x]^2) \\
 &= 4x^3(\gamma_{Ca^{2+}}\gamma_{F^-}^2)
 \end{aligned}$$

In order to look up the activity coefficients in the table, it is necessary to know the ionic strength of the solution. The ionic strength is due to the dissolved magnesium sulfate and the dissolved calcium fluoride. Since the equilibrium constant for the dissolution of calcium fluoride is quite small, assume that its contribution will be negligible, as in the earlier ionic strength calculation, and the only ions that need to be considered are the magnesium and sulfate ions. This gives an ionic strength of 0.050 M:

$$\mu = \frac{1}{2}([0.0125] \cdot 2^2 + [0.0125] \cdot (-2)^2) = 0.050M$$

## Solubility Products

Using this value for the ionic strength, the activity coefficients for calcium and fluoride ions are 0.485 and 0.81 respectively. Plugging into the equilibrium constant equation and solving for  $x$  gives

$$\begin{aligned}3.9 \times 10^{-11} &= [x] \cdot 0.485 \cdot [2x]^2 \cdot 0.81^2 \\x &= [Ca^{2+}] \\&= 3.1 \times 10^{-4} M\end{aligned}$$

If you had neglected the activity of the ions in solution you would have calculated the calcium ion concentration to be  $2.1 \times 10^{-4} M$ . This is a thirty-two percent error.

In this experiment, you will examine the effect of activities in determining an equilibrium constant, the solubility product. You will do a calculation similar to the example given, but you will determine the concentrations of the species in solution, and you will use these to calculate the solubility product both with and without including activity effects.

Your solutions are not likely to have an ionic strength exactly equal to one of those given in the table. While more sophisticated interpolation between values in the table are possible, it is sufficient for this experiment to simply use the tabulated value for that ionic strength that is closest to the value you calculate for your solution of interest. If your solution has an ionic strength exactly midway between two tabulated values, then use the value for the **lower** ionic strength.

## Procedure

---

**Work in pairs** on this experiment.

Each student must collect data and submit a separate report.

The actual data analyses and the written reports must be done entirely independently of your lab partner or other students. Make sure that you avoid unauthorized collaboration and plagiarism. All suspected violations of the Code of Academic Conduct will be referred to Student Judicial Affairs.

### Stock Chemicals Used

Chemical	Maximum Amount Used
Potassium Iodate, (s)	According to calculation (< 1 g)
Potassium Iodide, (s)	According to calculation (< 7 g)
1M Sodium Thiosulfate	According to calculation (< 15 mL)
Saturated Calcium Iodate, (aq)	< 10 mL
0.1M Potassium Iodate in Saturated Calcium Iodate, (aq)	< 10 mL
Starch Indicator	Small amounts (< 10 mL)
6M Hydrochloric Acid	< 6 mL

### Part I. Preparation of a Potassium Iodate Solution

1. In this procedure you will prepare a standard potassium iodate solution for use in standardizing a sodium thiosulfate solution.

Using a volumetric flask, accurately prepare 250 mL of a solution of approximately 0.01 M  $\text{KIO}_3$ . Note that this will need to be made as accurately as possible since this solution will serve as the primary standard for the experiment. The solid will take a few moments to dissolve. While you are waiting, go on to Part II.

### Part II. Preparation of a Sodium Thiosulfate Solution

2. In this procedure you will prepare and standardize a sodium thiosulfate solution. You will use the standard  $\text{KIO}_3$  solution prepared in Part I to standardize the sodium thiosulfate solution. The sodium thiosulfate solution will then become a secondary standard.

Using your clean 1 L plastic bottle, prepare about 250 mL of a 0.05 M  $\text{Na}_2\text{S}_2\text{O}_3$  solution. You should do this using the 1.0 M  $\text{Na}_2\text{S}_2\text{O}_3$  stock solution provided. Some calculations are required here.

### Safety First

---

Remember to always wear gloves when handling all solids.

**Wear your goggles!**

### Safety First

---

The potassium iodate primary standard is being dried in the oven. Be careful! The container is extremely hot.

**Always use crucible tongs to manipulate the container.**

### Hint

---

Using  $M_1V_1=M_2V_2$ , calculate the volume of 1.0M sodium thiosulfate solution needed to prepare your dilute solution.

### Part III. Standardization of the Sodium Thiosulfate Solution

- Standardize the sodium thiosulfate solution with the potassium iodate solution you have prepared. You should use the iodate-to-iodine and iodine-to-iodide reactions given in the introduction of the experiment. You will have to plan how to best perform this experiment. Here are some tips:

#### Green Chem

---

Do not waste chemicals. You should be using no more than a couple of grams of potassium iodide and a few milliliters of acid in each titration.

#### Hint

---

Do not add the starch indicator until the brown solution has lightened to a pale yellow.

- For the first reaction you will need excess potassium iodide and hydrochloric acid. If you were using a 5 mL sample of the standard potassium iodate solution it would require about 1 g of potassium iodide and about 1 mL of 6 M hydrochloric acid.

Begin by dissolving the potassium iodide (KI) in about 50 mL of water in your titration flask. Next, accurately add 5.0 mL of potassium iodate using volumetric glassware. Finally, add the hydrochloric acid. The solution will turn brown due to the formation of iodine.

- Now immediately titrate the solution with the sodium thiosulfate solution until the solution in the titration flask becomes a pale yellow color indicating only a limited amount of iodine present. At this point add 1 mL of the starch indicator. The starch will react with the  $I_3^-$  to form a complex that is dark blue in color. Continue the titration until the dark blue color just disappears.
- When you have completed each titration, pour the solution in the titration flask into an 800 mL beaker.
- Do at least three acceptable titrations so that you can calculate a meaningful average sodium thiosulfate concentration, standard deviation and 90% confidence limit for your data. An acceptable trial is one that passes the Q-test.

#### Titration Tips

---

- Do not use assembly line techniques when preparing flasks for titration; prepare a flask, titrate it, and then prepare the next flask. If you do not begin the titration immediately, iodine may crystallize out of solution and your titration results will be inaccurate.
  - Do not waste time. Only your limiting reagent needs to be measured out with volumetric glassware. The other reagents in the iodate-to-iodine reaction can be measured out reasonably roughly without affecting your results.
-



#### Part IV. Solubility and Solubility Product from a Saturated Calcium Iodate Solution

8. Determine the iodate concentration in a saturated solution of calcium iodate using your standard sodium thiosulfate solution. You should use the same procedure you developed for the thiosulfate standardization, but this time you will use a saturated calcium iodate solution instead of a potassium iodate solution when performing the first reaction.

The saturated calcium iodate solution will be provided by the stockroom. Make sure you read the labels on the bottles provided carefully; there are two calcium iodate solutions, and for this part of the experiment you are interested in the solution that has only calcium iodate dissolved in water.

Pour out the required amount carefully so that you do not disturb the solid  $\text{Ca}(\text{IO}_3)_2$  settled at the bottom of the bottle. You do **NOT** want any of the solid  $\text{Ca}(\text{IO}_3)_2$  in your Erlenmeyer flask. Pour out enough sample in a beaker so that you can conveniently but not wastefully use your 5.00 mL pipet to transfer the sample to an Erlenmeyer flask for the titration.

Add the same amount of KI and 6 M HCl in 50 mL of DI water that you did to standardize the thiosulfate solution, then add the 5.00 mL of saturated  $\text{Ca}(\text{IO}_3)_2$  solution for the titration.

When you have completed this titration, pour the solution in the titration flask into an 800 mL beaker.

You may only have time for a single titration for this part of the experiment. Do one titration then move on to Part V. If there is time remaining in the lab come back and repeat this titration.

### Part V. Solubility and $K_{sp}$ from a Saturated Calcium Iodate Solution in 0.010 M $KIO_3$

9. Determine the iodate concentration in a saturated solution of calcium iodate in 0.010 M  $KIO_3$  using standard sodium thiosulfate solution. This saturated solution is prepared by dissolving enough potassium iodate in water to make it 0.010 M in iodate and then saturating the solution with calcium iodate. This solution will also be provided by the stockroom. Again, read the label carefully; do not confuse this solution with the saturated calcium iodate solution you used in the previous part of this experiment.

Pour out the required amount carefully so that you do not disturb the solid  $Ca(IO_3)_2$  settled at the bottom of the bottle. You do NOT want any of the solid  $Ca(IO_3)_2$  in your Erlenmeyer flask. Pour out enough sample in a beaker so that you can conveniently but not wastefully use your 5.00 mL pipet to transfer the sample to an Erlenmeyer flask for the titration. Add the same amount of KI and 6 M HCl in 50 mL of DI water that you did to standardize the thiosulfate solution, then add the 5.00 mL of saturated  $Ca(IO_3)_2$  in 0.010 M  $KIO_3$  solution for the titration.

When you have completed this titration, pour the solution in the titration flask into an 800 mL beaker.

You only have time to do a single titration for this part of the experiment. Do one titration then go back to Part IV. After you have done a second titration for Part IV do a second titration for this part of the experiment if time permits.

#### Clean Up

- Pour any remaining HCl into the 800 mL beaker. Slowly and carefully add 3 grams of sodium bicarbonate. Pour this solution down the sink with copious amounts of water.

## Data Analysis

---

### Part I

1. What was the mass of  $\text{KIO}_3$  that you dissolved in 250.0 mL of de-ionized water to make your primary standard solution?
2. What was the resulting molarity of your primary standard solution of  $\text{KIO}_3$ ?

### Part II

3. What volume of 1 M  $\text{Na}_2\text{S}_2\text{O}_3$  stock solution did you use to prepare 250 mL of 0.05 M  $\text{Na}_2\text{S}_2\text{O}_3$ ?

### Part III

4. What is the stoichiometric factor, that is the number of moles of  $\text{Na}_2\text{S}_2\text{O}_3$  reacting with one mole of  $\text{KIO}_3$ ?
5. For each of your three trials, what volume of  $\text{Na}_2\text{S}_2\text{O}_3$  was required to reach the endpoint?

What is the molarity of the  $\text{Na}_2\text{S}_2\text{O}_3$  that you calculate for each of your three trials in the same order in which you entered the volumes?

6. What is the average molarity and the standard deviation of the  $\text{Na}_2\text{S}_2\text{O}_3$  solution based on your three trials?

### Part IV

7. How many trials were you able to complete for the determination of  $\text{IO}_3^-$  in the saturated solution of  $\text{Ca}(\text{IO}_3)_2$  in pure water solvent?
8. What volume of the saturated solution of  $\text{Ca}(\text{IO}_3)_2$  in pure water did you use as a sample for titration with  $\text{Na}_2\text{SO}_3$ ?
9. For each of the trials you performed, what volume of standardized  $\text{Na}_2\text{SO}_3$  was required to reach the endpoint?
10. For each of the trials you performed, how many moles of  $\text{IO}_3^-$  were present? If you performed multiple trials, what was the average number of moles of  $\text{IO}_3^-$  present?
11. Based on the number of moles of  $\text{IO}_3^-$  present in your sample(s) and the volume of that sample, what is the solubility of  $\text{Ca}(\text{IO}_3)_2$  in the saturated solution in pure water?

### Part V

You will now calculate the concentration of the iodate present in your final solution. When you do this calculation, make sure that you account for the fact that there is 0.010 M iodate present that does not come from the dissolved  $\text{Ca}(\text{IO}_3)_2$ .

## Solubility Products

12. How many trials were you able to complete for the determination of  $\text{IO}_3^-$  in the saturated solution of  $\text{Ca}(\text{IO}_3)_2$  in the solution containing 0.01M potassium iodate  $\text{KIO}_3$ ?
13. What volume of the saturated solution of  $\text{Ca}(\text{IO}_3)_2$  in 0.01 M  $\text{KIO}_3$  did you use as a sample for titration with  $\text{Na}_2\text{SO}_3$ ?
14. For each of the trials you performed, what volume of standardized  $\text{Na}_2\text{SO}_3$  was required to reach the endpoint?
15. For each of the trials you performed, how many moles of  $\text{IO}_3^-$  were present? If you performed multiple trials, what was the average number of moles of  $\text{IO}_3^-$  present?
16. Based on the number of moles of  $\text{IO}_3^-$  present in your sample(s) and the volume of that sample, what is the solubility of  $\text{Ca}(\text{IO}_3)_2$  in the saturated solution in 0.01 M  $\text{KIO}_3$ ?

### Comparison of solubility values

17. Examine the values you have obtained for the solubility of  $\text{Ca}(\text{IO}_3)_2$  in pure water and in 0.01 M  $\text{KIO}_3$ . Is the value of solubility significantly different in pure water and in 0.01 M  $\text{KIO}_3$ ? Explain any difference you may observe.

### Calculating $K_{\text{sp}}$ based on concentration

18. Using the concentration of  $\text{Ca}(\text{IO}_3)_2$  that you determined in the saturated solution in pure water, what is the value of  $K_{\text{sp}}$  that you calculate using the expression in concentrations alone?
19. Using the concentration of  $\text{Ca}(\text{IO}_3)_2$  that you determined in the saturated solution in 0.01 M  $\text{KIO}_3$ , calculate the value of  $K_{\text{sp}}$  that you calculate using the expression in concentrations alone?

### Calculating $K_{\text{sp}}$ based on activity

20. What is the ionic strength of the saturated solution of  $\text{Ca}(\text{IO}_3)_2$  in pure water?
21. Using the activity coefficients from TABLE I. appropriate for the ionic strength of the saturated  $\text{Ca}(\text{IO}_3)_2$  in pure water, calculate  $K_{\text{sp}}$  using activities?
22. What is the ionic strength of the saturated solution of  $\text{Ca}(\text{IO}_3)_2$  in 0.01 M  $\text{KIO}_3$ ?
23. Using the activity coefficients from TABLE I. appropriate for the ionic strength of the saturated  $\text{Ca}(\text{IO}_3)_2$  in 0.01 M  $\text{KIO}_3$  solution, calculate  $K_{\text{sp}}$  using activities?

**Comparison of  $K_{sp}$  values**

24. Examine the values you have obtained for  $K_{sp}$  for  $\text{Ca}(\text{IO}_3)_2$  in pure water and in 0.01 M  $\text{KIO}_3$  both recognizing the presence of activity effects and based upon concentrations alone. Is the value of  $K_{sp}$  significantly different in pure water and in 0.01 M  $\text{KIO}_3$ ? Is any difference you calculate affected by the recognition of activity effects?

**Conclusion.**

Reflect on the experimental procedures you have undertaken and the possible sources of error. Then write a summary paragraph comparing your results, commenting upon the common ion effect and its influence on solubility, and commenting upon activity effects and their influence on the value of  $K_{sp}$ .



# Chem 2 Series Laboratory

# Procedures and Safety Handbook

# Appendix Table of Contents

<b>General Experimental Guidelines</b>	<b>A-5</b>
1. Pre-Laboratory Preparation	
2. Data Collection	
3. Unknowns	
4. Writing A Laboratory Report	
<b>Laboratory Work Grading Policies</b>	<b>A-7</b>
<b>Late Reports &amp; Make-Up Policy</b>	<b>A-8</b>
1. Late Reports	
2. Laboratory Make-Up Policy	
3. Laboratory Make-up Procedure	
4. Plagiarism and Unauthorized Collaboration	
<b>Procedures for Online Pre- &amp; Post-Laboratory</b>	<b>A-9</b>
<b>Accessing the Website      A-9</b>	
1. Viewing the Pre-laboratory Presentations.	
2. Taking the Pre-Lab Quiz	
3. Completing the Post-Laboratory Exercises.	
<b>Scoring Scheme      A-15</b>	
<b>Due Date/Late Submission of Post-lab Exercise      A-16</b>	
<b>Chemistry Department Safety Policy</b>	<b>A-17</b>
<b>Safety in the Chemistry 2 Laboratories</b>	<b>A-19</b>
<b>Safe Laboratory Practices      A-19</b>	
1. Work Under Supervision	
2. Follow Instructions	
3. Safety Equipment	
4. Practice Good Housekeeping	
5. Avoid Chemical Contamination	
<b>Personal Protective Equipment (PPE)      A-21</b>	
1. Dress Code	
2. Goggles	
3. Lab Coat	
4. Gloves	
<b>Maps and Emergency Evacuation Procedures</b>	<b>A-23</b>
1. Prior to Exiting	
2. Evacuation Routes/Exiting the Building	
3. Assembly Area	
<b>General Emergency Procedures</b>	<b>A-27</b>
1. Medical Emergency	
2. Major Incident	
3. Fire Alarm	
<b>Dispensary Procedures</b>	<b>A-28</b>



Safety Data Sheet	A-29
Hazardous Chemicals	A-38
Hazardous Chemicals	A-38
Hazardous Waste	A-39
Statistical Treatment of Data	A-42
1. Average and Standard Deviation	
2. Confidence Limits	
3. Relative Deviation	
4. Analysis of Poor Data: Q-test	
An Introduction to Excel	A-45
Excel Basics	A-46
Calculations in Excel	A-50
Graphing in Excel	A-53
Common Laboratory Procedures	A-57
Handling Solids	A-57
1. General Guidelines for Handling Solids	
2. Quantitative Transfer	
3. Using the Desiccator	
Handling Liquids	A-59
1. Drawing Solutions from a Reagent Bottle	
2. Estimating Volume with a Dispo Pipet	
3. Transferring Liquid	
4. Capping a Flask with Parafilm	
5. Measuring Liquid Volumes	
Common Glassware in the Laboratory	A-62
1. Care and Maintenance of Laboratory Glassware	
2. Beakers	
3. Erlenmeyer Flasks	
4. Graduated Cylinder	
5. Volumetric Flasks	
6. Burets	
7. Volumetric Pipet	
Using the Balance	A-68
1. On/Off Switching	
2. Simple Weighing	
3. Taring	
4. Weighing by Difference	
Using the Centrifuge	A-70
1. Procedure	
2. Safety Precautions	
Using the Hot Plate	A-71
1. Features	
2. Safety Precautions	
Heating with a Bunsen Burner	A-73
Filtration	A-74

**pH Meter Operating Instructions     A-75**

1.    Preparing the pH meter
2.    Calibrating the pH meter
3.    Measure the pH of sample

**Fume Hood Use and Safety     A-78**

1.    Features of the Fume Hood
2.    Before using the fume hood
3.    Guidelines for working with the fume hood
4.    Using the fume hoods in the Chemistry 2 Laboratories
5.    Fume Hood Emissions

**Locker Inventory**

**A-81**

Start of Quarter Check-In     **A-81**

End of Quarter Check-Out     **A-82**

# General Experimental Guidelines

---

The laboratory is a critical component of your study of chemistry. Therefore, a student must complete **all of the assigned laboratory work**, including all on- & off-line post-laboratory exercises, in order to pass this course.

## 1. Pre-Laboratory Preparation

- You are required to prepare for each experiment by doing the following:
- Carefully read the experiment and write a Title, Purpose, Procedure (brief outline), and Data (outline) section before arriving at the laboratory. A detailed description of each section is described below under, "Writing a Laboratory Report".
- You must complete the on-line pre-laboratory presentation and must pass the pre-laboratory quiz.

**If you have not completed the pre-lab preparation** at the beginning of the laboratory period, you will be deemed unsafe to perform the experiment and must leave the laboratory until the pre-laboratory write up is complete and your TA is convinced that you are prepared to begin the experiment.

## 2. Data Collection

All data must be recorded *in blue or black ink* directly into your laboratory notebook. At the completion of the experiment, you must turn in a copy of your data sheet to your TA *before* you leave the laboratory.

## 3. Unknowns

Students will obtain all unknowns from the TA. Students must be explicit in their request for an unknown; that is, they must know the name of the experiment and unknown. If a student needs more unknown, they should notify the TA who will then write a note of explanation that the student can take to the dispensary. The note should contain the student's name, the student's locker number, the laboratory section number, the TA's name, the experiment name, and the name of the unknown.

## 4. Writing A Laboratory Report

Below is the suggested format that your report should follow. Portions of the report should be written in your laboratory notebook and others will be submitted on-line as part of the post laboratory exercises. Post laboratory exercises are due one week after the completion of the laboratory.

## General Experimental Guidelines

Below is a general outline of a common format that is often used in science laboratory courses. Discuss this format with your TA during the first laboratory period so that you clearly understand what will be expected. All reports must be written in **non-erasable blue or black ink**. A date should be indicated on each report. Your notebook should be organized and written in such a manner that another chemist could read it and repeat the experiment in precisely the same way.

- **Title:** The report should have a title that concisely describes the experiment.
- **Purpose:** A brief and concise statement that describes the goals of the experiment and the methods employed. Any pertinent chemical reactions are generally indicated. State the purpose of the experiment in the form of a complete sentence. Do not start with the word "To."
- **Procedure:** A brief and concise outline of each step of the experiment should be included. If you are using a published procedure, you should also cite the literature or laboratory manual. A drawing of the apparatus may also be included.
- **Data and Observations:** Report all measurements and observations that are pertinent to the experiment. Be sure to note any problems or unexpected occurrences. It is important that this section be as neat and as organized as possible. The use of tables will often help in this regard. All data must be recorded in **blue or black ink** directly into the notebook at the time it is collected. A severe penalty will be imposed for pencil or transcribed data entries. Do not erase mistakes. Simply draw a line through the error and record the correction. Your notebook is subject to examination at any time.

The following sections are to be submitted on-line as part of the post-laboratory exercise. You should complete the post-lab report as soon as possible after the completion of the experiment as this is much more efficient than waiting until the night before the experiment is due.

- **Calculations:** This section generally includes any complicated calculations that are involved in the experiment. Again, it is important to use foresight when organizing this section.
- **Questions:** All assigned questions are answered in this section.
- **Results & Conclusions:** Report the outcome of the experiment.

# Laboratory Work Grading Policies

---

**1. Pre-lab lab notebook preparation incomplete:**

- 30% of post-lab score deduction for first offense.
- 70% of post lab score deduction for subsequent offenses.
- No extra time or make-up

**2. Online Pre-lab quiz failed or incomplete 1 hour before lab begins:**

- 0/2 points for the pre-lab quiz

**3. Late reports**

- 5-point deduction for every calendar day the report is late

# Late Reports & Make-Up Policy

---

## 1. Late Reports

Laboratory reports are due at the beginning of the period after the one allocated for the completion of the experiment. The last report each quarter is due at the time indicated by the TA. Late reports will be met with a 5-point deduction for every calendar day the report is late.

## 2. Laboratory Make-Up Policy

You must attend the laboratory class for the section in which they are enrolled. **If you miss a laboratory class with an excused absence, it must be made up before the end of the following week of laboratory. No laboratory make-ups will be offered after one week from the scheduled date of the lab.** No make ups for unexcused absences.

**Excused absences include an extended illness, accidents, or family emergencies. Vacation, cruises, and IM sports are not considered excused.** Bring documented proof of your excused absence to your TA or head TA immediately upon return. If you cannot present this documentation or have an unexcused absence, you may receive a failing grade in the course.

If you miss the last lab of the quarter, it must be made up **immediately**.

## 3. Laboratory Make-up Procedure

You are required to complete all labs in order to pass the course and it is your responsibility to make up any missed labs promptly. Failure to make up a lab may result in a **failing grade** for the course.

If you miss a lab, you must make it up by attending another scheduled laboratory section. Consult the Class Schedule and Room Directory for a listing of rooms and times. Go to the selected laboratory section and ask the teaching assistant if you may be admitted to make up a lab. You must be on time for the start of the lab period. If there is room in the class, the teaching assistant will allow you in the lab, unlock your locker, and allow you to do the lab. Make sure to record the **teaching assistant's name, date, time and room number** where you made up the laboratory. Have the TA collect your data sheet and he or she will give it to your regularly assigned teaching assistant. **No laboratory report will be accepted without a valid copy of the data sheet.**

## 4. Plagiarism and Unauthorized Collaboration

Some of your experiments will be done with lab partners. You are encouraged to discuss your data and its analysis and interpretation with your lab partner, other students and the TAs. However, the actual data analyses and the written reports **must** be done entirely independently of your lab partner or other students. Make sure that you avoid unauthorized collaboration and plagiarism. All suspected violations of the Code of Academic Conduct will be referred to Student Judicial Affairs.

# Procedures for Online Pre- & Post-Laboratory

The Department of Chemistry is introducing on-line pre-& post-laboratory activities. The purpose of the pre-laboratory presentations is to aid the student in preparing for the laboratories. Each post-laboratory exercise is designed to guide you through the calculations or concepts that apply.

- **Prior to doing any online and laboratory activities**, all students are required to complete the Safety Quiz online after watching the online safety videos.
- **Prior to coming to the laboratory class**, the pre-laboratory exercises are to be viewed and the pre-lab quiz must be completed on-line.

Read your Laboratory Manual and complete your pre-laboratory write up before viewing on-line pre-laboratory presentation.

Have laboratory notebook and calculator with you when viewing the on-line pre-laboratory presentation or completing the post-laboratory exercises. **Plan ahead.** As with any computer activity, the on-line activities may take time to complete. Do not wait until the last minute to complete any of the required on-line activities.

## Accessing the Website

Each time you access the On-Line Chemistry 2 Laboratory website you must do so through Canvas and/or the web address given by your instructor.

- The Welcome Page tests whether the Flash plug-in is working. If you do not have the correct Flash player installed. If you do not see the movie on the Welcome page, then there is no guarantee that you will be able to view all videos and slides.

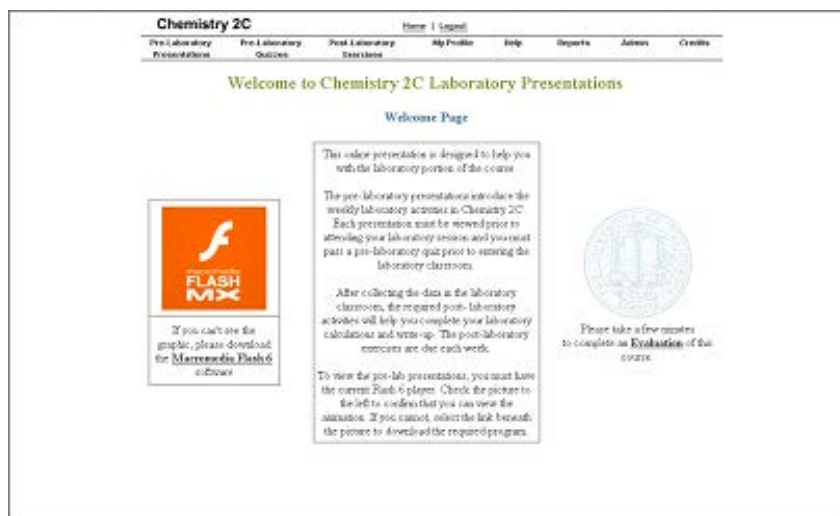

## Procedures for Online Pre- & Post-Laboratory

b.) Click on “My Profile” to enter your personal information.

The screenshot shows the 'Edit My Personal Information' page. At the top, there is a navigation bar with 'Home | Logout' and a menu with 'Pre-Laboratory Presentations', 'Pre-Laboratory Outlets', 'Post-Laboratory Exercises', 'My Profile', 'Help', 'Reports', 'Admin', and 'Credits'. The main heading is 'Edit My Personal Information'. Below this, there are several form fields: 'Your First name (as it appears in registration)', 'Your Last name (as it appears in registration)', 'Preferred name (name by which you are called)', 'Your UC Davis LogiD', 'Your Password (do NOT use your Kerberos password)', 'Confirm Password Change (re-type Password)', and 'Your full email address (required)'. There is also a dropdown menu for 'Change from not using CD (15+ CD)' with options 'Drive C', 'Drive E', and 'Drive F'. At the bottom, there are 'Submit Changes' and 'Reset' buttons. Below the form, there is a link 'Return to My Profile Menu' and a note: 'If you don't want to make any changes, please select the "Return to My Profile Menu" link.' At the very bottom, there is a small copyright notice: 'Copyright © 2004, 2005, 2006, 2007, 2008, 2009, 2010, 2011, 2012, 2013, 2014, 2015, 2016, 2017, 2018, 2019, 2020, 2021, 2022, 2023, 2024, 2025, 2026, 2027, 2028, 2029, 2030, 2031, 2032, 2033, 2034, 2035, 2036, 2037, 2038, 2039, 2040, 2041, 2042, 2043, 2044, 2045, 2046, 2047, 2048, 2049, 2050, 2051, 2052, 2053, 2054, 2055, 2056, 2057, 2058, 2059, 2060, 2061, 2062, 2063, 2064, 2065, 2066, 2067, 2068, 2069, 2070, 2071, 2072, 2073, 2074, 2075, 2076, 2077, 2078, 2079, 2080, 2081, 2082, 2083, 2084, 2085, 2086, 2087, 2088, 2089, 2090, 2091, 2092, 2093, 2094, 2095, 2096, 2097, 2098, 2099, 2100, 2101, 2102, 2103, 2104, 2105, 2106, 2107, 2108, 2109, 2110, 2111, 2112, 2113, 2114, 2115, 2116, 2117, 2118, 2119, 2120, 2121, 2122, 2123, 2124, 2125, 2126, 2127, 2128, 2129, 2130, 2131, 2132, 2133, 2134, 2135, 2136, 2137, 2138, 2139, 2140, 2141, 2142, 2143, 2144, 2145, 2146, 2147, 2148, 2149, 2150, 2151, 2152, 2153, 2154, 2155, 2156, 2157, 2158, 2159, 2160, 2161, 2162, 2163, 2164, 2165, 2166, 2167, 2168, 2169, 2170, 2171, 2172, 2173, 2174, 2175, 2176, 2177, 2178, 2179, 2180, 2181, 2182, 2183, 2184, 2185, 2186, 2187, 2188, 2189, 2190, 2191, 2192, 2193, 2194, 2195, 2196, 2197, 2198, 2199, 2200, 2201, 2202, 2203, 2204, 2205, 2206, 2207, 2208, 2209, 2210, 2211, 2212, 2213, 2214, 2215, 2216, 2217, 2218, 2219, 2220, 2221, 2222, 2223, 2224, 2225, 2226, 2227, 2228, 2229, 2230, 2231, 2232, 2233, 2234, 2235, 2236, 2237, 2238, 2239, 2240, 2241, 2242, 2243, 2244, 2245, 2246, 2247, 2248, 2249, 2250, 2251, 2252, 2253, 2254, 2255, 2256, 2257, 2258, 2259, 2260, 2261, 2262, 2263, 2264, 2265, 2266, 2267, 2268, 2269, 2270, 2271, 2272, 2273, 2274, 2275, 2276, 2277, 2278, 2279, 2280, 2281, 2282, 2283, 2284, 2285, 2286, 2287, 2288, 2289, 2290, 2291, 2292, 2293, 2294, 2295, 2296, 2297, 2298, 2299, 2300, 2301, 2302, 2303, 2304, 2305, 2306, 2307, 2308, 2309, 2310, 2311, 2312, 2313, 2314, 2315, 2316, 2317, 2318, 2319, 2320, 2321, 2322, 2323, 2324, 2325, 2326, 2327, 2328, 2329, 2330, 2331, 2332, 2333, 2334, 2335, 2336, 2337, 2338, 2339, 2340, 2341, 2342, 2343, 2344, 2345, 2346, 2347, 2348, 2349, 2350, 2351, 2352, 2353, 2354, 2355, 2356, 2357, 2358, 2359, 2360, 2361, 2362, 2363, 2364, 2365, 2366, 2367, 2368, 2369, 2370, 2371, 2372, 2373, 2374, 2375, 2376, 2377, 2378, 2379, 2380, 2381, 2382, 2383, 2384, 2385, 2386, 2387, 2388, 2389, 2390, 2391, 2392, 2393, 2394, 2395, 2396, 2397, 2398, 2399, 2400, 2401, 2402, 2403, 2404, 2405, 2406, 2407, 2408, 2409, 2410, 2411, 2412, 2413, 2414, 2415, 2416, 2417, 2418, 2419, 2420, 2421, 2422, 2423, 2424, 2425, 2426, 2427, 2428, 2429, 2430, 2431, 2432, 2433, 2434, 2435, 2436, 2437, 2438, 2439, 2440, 2441, 2442, 2443, 2444, 2445, 2446, 2447, 2448, 2449, 2450, 2451, 2452, 2453, 2454, 2455, 2456, 2457, 2458, 2459, 2460, 2461, 2462, 2463, 2464, 2465, 2466, 2467, 2468, 2469, 2470, 2471, 2472, 2473, 2474, 2475, 2476, 2477, 2478, 2479, 2480, 2481, 2482, 2483, 2484, 2485, 2486, 2487, 2488, 2489, 2490, 2491, 2492, 2493, 2494, 2495, 2496, 2497, 2498, 2499, 2500, 2501, 2502, 2503, 2504, 2505, 2506, 2507, 2508, 2509, 2510, 2511, 2512, 2513, 2514, 2515, 2516, 2517, 2518, 2519, 2520, 2521, 2522, 2523, 2524, 2525, 2526, 2527, 2528, 2529, 2530, 2531, 2532, 2533, 2534, 2535, 2536, 2537, 2538, 2539, 2540, 2541, 2542, 2543, 2544, 2545, 2546, 2547, 2548, 2549, 2550, 2551, 2552, 2553, 2554, 2555, 2556, 2557, 2558, 2559, 2560, 2561, 2562, 2563, 2564, 2565, 2566, 2567, 2568, 2569, 2570, 2571, 2572, 2573, 2574, 2575, 2576, 2577, 2578, 2579, 2580, 2581, 2582, 2583, 2584, 2585, 2586, 2587, 2588, 2589, 2590, 2591, 2592, 2593, 2594, 2595, 2596, 2597, 2598, 2599, 2600, 2601, 2602, 2603, 2604, 2605, 2606, 2607, 2608, 2609, 2610, 2611, 2612, 2613, 2614, 2615, 2616, 2617, 2618, 2619, 2620, 2621, 2622, 2623, 2624, 2625, 2626, 2627, 2628, 2629, 2630, 2631, 2632, 2633, 2634, 2635, 2636, 2637, 2638, 2639, 2640, 2641, 2642, 2643, 2644, 2645, 2646, 2647, 2648, 2649, 2650, 2651, 2652, 2653, 2654, 2655, 2656, 2657, 2658, 2659, 2660, 2661, 2662, 2663, 2664, 2665, 2666, 2667, 2668, 2669, 2670, 2671, 2672, 2673, 2674, 2675, 2676, 2677, 2678, 2679, 2680, 2681, 2682, 2683, 2684, 2685, 2686, 2687, 2688, 2689, 2690, 2691, 2692, 2693, 2694, 2695, 2696, 2697, 2698, 2699, 2700, 2701, 2702, 2703, 2704, 2705, 2706, 2707, 2708, 2709, 2710, 2711, 2712, 2713, 2714, 2715, 2716, 2717, 2718, 2719, 2720, 2721, 2722, 2723, 2724, 2725, 2726, 2727, 2728, 2729, 2730, 2731, 2732, 2733, 2734, 2735, 2736, 2737, 2738, 2739, 2740, 2741, 2742, 2743, 2744, 2745, 2746, 2747, 2748, 2749, 2750, 2751, 2752, 2753, 2754, 2755, 2756, 2757, 2758, 2759, 2760, 2761, 2762, 2763, 2764, 2765, 2766, 2767, 2768, 2769, 2770, 2771, 2772, 2773, 2774, 2775, 2776, 2777, 2778, 2779, 2780, 2781, 2782, 2783, 2784, 2785, 2786, 2787, 2788, 2789, 2790, 2791, 2792, 2793, 2794, 2795, 2796, 2797, 2798, 2799, 2800, 2801, 2802, 2803, 2804, 2805, 2806, 2807, 2808, 2809, 2810, 2811, 2812, 2813, 2814, 2815, 2816, 2817, 2818, 2819, 2820, 2821, 2822, 2823, 2824, 2825, 2826, 2827, 2828, 2829, 2830, 2831, 2832, 2833, 2834, 2835, 2836, 2837, 2838, 2839, 2840, 2841, 2842, 2843, 2844, 2845, 2846, 2847, 2848, 2849, 2850, 2851, 2852, 2853, 2854, 2855, 2856, 2857, 2858, 2859, 2860, 2861, 2862, 2863, 2864, 2865, 2866, 2867, 2868, 2869, 2870, 2871, 2872, 2873, 2874, 2875, 2876, 2877, 2878, 2879, 2880, 2881, 2882, 2883, 2884, 2885, 2886, 2887, 2888, 2889, 2890, 2891, 2892, 2893, 2894, 2895, 2896, 2897, 2898, 2899, 2900, 2901, 2902, 2903, 2904, 2905, 2906, 2907, 2908, 2909, 2910, 2911, 2912, 2913, 2914, 2915, 2916, 2917, 2918, 2919, 2920, 2921, 2922, 2923, 2924, 2925, 2926, 2927, 2928, 2929, 2930, 2931, 2932, 2933, 2934, 2935, 2936, 2937, 2938, 2939, 2940, 2941, 2942, 2943, 2944, 2945, 2946, 2947, 2948, 2949, 2950, 2951, 2952, 2953, 2954, 2955, 2956, 2957, 2958, 2959, 2960, 2961, 2962, 2963, 2964, 2965, 2966, 2967, 2968, 2969, 2970, 2971, 2972, 2973, 2974, 2975, 2976, 2977, 2978, 2979, 2980, 2981, 2982, 2983, 2984, 2985, 2986, 2987, 2988, 2989, 2990, 2991, 2992, 2993, 2994, 2995, 2996, 2997, 2998, 2999, 3000, 3001, 3002, 3003, 3004, 3005, 3006, 3007, 3008, 3009, 3010, 3011, 3012, 3013, 3014, 3015, 3016, 3017, 3018, 3019, 3020, 3021, 3022, 3023, 3024, 3025, 3026, 3027, 3028, 3029, 3030, 3031, 3032, 3033, 3034, 3035, 3036, 3037, 3038, 3039, 3040, 3041, 3042, 3043, 3044, 3045, 3046, 3047, 3048, 3049, 3050, 3051, 3052, 3053, 3054, 3055, 3056, 3057, 3058, 3059, 3060, 3061, 3062, 3063, 3064, 3065, 3066, 3067, 3068, 3069, 3070, 3071, 3072, 3073, 3074, 3075, 3076, 3077, 3078, 3079, 3080, 3081, 3082, 3083, 3084, 3085, 3086, 3087, 3088, 3089, 3090, 3091, 3092, 3093, 3094, 3095, 3096, 3097, 3098, 3099, 3100, 3101, 3102, 3103, 3104, 3105, 3106, 3107, 3108, 3109, 3110, 3111, 3112, 3113, 3114, 3115, 3116, 3117, 3118, 3119, 3120, 3121, 3122, 3123, 3124, 3125, 3126, 3127, 3128, 3129, 3130, 3131, 3132, 3133, 3134, 3135, 3136, 3137, 3138, 3139, 3140, 3141, 3142, 3143, 3144, 3145, 3146, 3147, 3148, 3149, 3150, 3151, 3152, 3153, 3154, 3155, 3156, 3157, 3158, 3159, 3160, 3161, 3162, 3163, 3164, 3165, 3166, 3167, 3168, 3169, 3170, 3171, 3172, 3173, 3174, 3175, 3176, 3177, 3178, 3179, 3180, 3181, 3182, 3183, 3184, 3185, 3186, 3187, 3188, 3189, 3190, 3191, 3192, 3193, 3194, 3195, 3196, 3197, 3198, 3199, 3200, 3201, 3202, 3203, 3204, 3205, 3206, 3207, 3208, 3209, 3210, 3211, 3212, 3213, 3214, 3215, 3216, 3217, 3218, 3219, 3220, 3221, 3222, 3223, 3224, 3225, 3226, 3227, 3228, 3229, 3230, 3231, 3232, 3233, 3234, 3235, 3236, 3237, 3238, 3239, 3240, 3241, 3242, 3243, 3244, 3245, 3246, 3247, 3248, 3249, 3250, 3251, 3252, 3253, 3254, 3255, 3256, 3257, 3258, 3259, 3260, 3261, 3262, 3263, 3264, 3265, 3266, 3267, 3268, 3269, 3270, 3271, 3272, 3273, 3274, 3275, 3276, 3277, 3278, 3279, 3280, 3281, 3282, 3283, 3284, 3285, 3286, 3287, 3288, 3289, 3290, 3291, 3292, 3293, 3294, 3295, 3296, 3297, 3298, 3299, 3300, 3301, 3302, 3303, 3304, 3305, 3306, 3307, 3308, 3309, 3310, 3311, 3312, 3313, 3314, 3315, 3316, 3317, 3318, 3319, 3320, 3321, 3322, 3323, 3324, 3325, 3326, 3327, 3328, 3329, 3330, 3331, 3332, 3333, 3334, 3335, 3336, 3337, 3338, 3339, 3340, 3341, 3342, 3343, 3344, 3345, 3346, 3347, 3348, 3349, 3350, 3351, 3352, 3353, 3354, 3355, 3356, 3357, 3358, 3359, 3360, 3361, 3362, 3363, 3364, 3365, 3366, 3367, 3368, 3369, 3370, 3371, 3372, 3373, 3374, 3375, 3376, 3377, 3378, 3379, 3380, 3381, 3382, 3383, 3384, 3385, 3386, 3387, 3388, 3389, 3390, 3391, 3392, 3393, 3394, 3395, 3396, 3397, 3398, 3399, 3400, 3401, 3402, 3403, 3404, 3405, 3406, 3407, 3408, 3409, 3410, 3411, 3412, 3413, 3414, 3415, 3416, 3417, 3418, 3419, 3420, 3421, 3422, 3423, 3424, 3425, 3426, 3427, 3428, 3429, 3430, 3431, 3432, 3433, 3434, 3435, 3436, 3437, 3438, 3439, 3440, 3441, 3442, 3443, 3444, 3445, 3446, 3447, 3448, 3449, 3450, 3451, 3452, 3453, 3454, 3455, 3456, 3457, 3458, 3459, 3460, 3461, 3462, 3463, 3464, 3465, 3466, 3467, 3468, 3469, 3470, 3471, 3472, 3473, 3474, 3475, 3476, 3477, 3478, 3479, 3480, 3481, 3482, 3483, 3484, 3485, 3486, 3487, 3488, 3489, 3490, 3491, 3492, 3493, 3494, 3495, 3496, 3497, 3498, 3499, 3500, 3501, 3502, 3503, 3504, 3505, 3506, 3507, 3508, 3509, 3510, 3511, 3512, 3513, 3514, 3515, 3516, 3517, 3518, 3519, 3520, 3521, 3522, 3523, 3524, 3525, 3526, 3527, 3528, 3529, 3530, 3531, 3532, 3533, 3534, 3535, 3536, 3537, 3538, 3539, 3540, 3541, 3542, 3543, 3544, 3545, 3546, 3547, 3548, 3549, 3550, 3551, 3552, 3553, 3554, 3555, 3556, 3557, 3558, 3559, 3560, 3561, 3562, 3563, 3564, 3565, 3566, 3567, 3568, 3569, 3570, 3571, 3572, 3573, 3574, 3575, 3576, 3577, 3578, 3579, 3580, 3581, 3582, 3583, 3584, 3585, 3586, 3587, 3588, 3589, 3590, 3591, 3592, 3593, 3594, 3595, 3596, 3597, 3598, 3599, 3600, 3601, 3602, 3603, 3604, 3605, 3606, 3607, 3608, 3609, 3610, 3611, 3612, 3613, 3614, 3615, 3616, 3617, 3618, 3619, 3620, 3621, 3622, 3623, 3624, 3625, 3626, 3627, 3628, 3629, 3630, 3631, 3632, 3633, 3634, 3635, 3636, 3637, 3638, 3639, 3640, 3641, 3642, 3643, 3644, 3645, 3646, 3647, 3648, 3649, 3650, 3651, 3652, 3653, 3654, 3655, 3656, 3657, 3658, 3659, 3660, 3661, 3662, 3663, 3664, 3665, 3666, 3667, 3668, 3669, 3670, 3671, 3672, 3673, 3674, 3675, 3676, 3677, 3678, 3679, 3680, 3681, 3682, 3683, 3684, 3685, 3686, 3687, 3688, 3689, 3690, 3691, 3692, 3693, 3694, 3695, 3696, 3697, 3698, 3699, 3700, 3701, 3702, 3703, 3704, 3705, 3706, 3707, 3708, 3709, 3710, 3711, 3712, 3713, 3714, 3715, 3716, 3717, 3718, 3719, 3720, 3721, 3722, 3723, 3724, 3725, 3726, 3727, 3728, 3729, 3730, 3731, 3732, 3733, 3734, 3735, 3736, 3737, 3738, 3739, 3740, 3741, 3742, 3743, 3744, 3745, 3746, 3747, 3748, 3749, 3750, 3751, 3752, 3753, 3754, 3755, 3756, 3757, 3758, 3759, 3760, 3761, 3762, 3763, 3764, 3765, 3766, 3767, 3768, 3769, 3770, 3771, 3772, 3773, 3774, 3775, 3776, 3777, 3778, 3779, 3780, 3781, 3782, 3783, 3784, 3785, 3786, 3787, 3788, 3789, 3790, 3791, 3792, 3793, 3794, 3795, 3796, 3797, 3798, 3799, 3800, 3801, 3802, 3803, 3804, 3805, 3806, 3807, 3808, 3809, 3810, 3811, 3812, 3813, 3814, 3815, 3816, 3817, 3818, 3819, 3820, 3821, 3822, 3823, 3824, 3825, 3826, 3827, 3828, 3829, 3830, 3831, 3832, 3833, 3834, 3835, 3836, 3837, 3838, 3839, 3840, 3841, 3842, 3843, 3844, 3845, 3846, 3847, 3848, 3849, 3850, 3851, 3852, 3853, 3854, 3855, 3856, 3857, 3858, 3859, 3860, 3861, 3862, 3863, 3864, 3865, 3866, 3867, 3868, 3869, 3870, 3871, 3872, 3873, 3874, 3875, 3876, 3877, 3878, 3879, 3880, 3881, 3882, 3883, 3884, 3885, 3886, 3887, 3888, 3889, 3890, 3891, 3892, 3893, 3894, 3895, 3896, 3897, 3898, 3899, 3900, 3901, 3902, 3903, 3904, 3905, 3906, 3907, 3908, 3909, 3910, 3911, 3912, 3913, 3914, 3915, 3916, 3917, 3918, 3919, 3920, 3921, 3922, 3923, 3924, 3925, 3926, 3927, 3928, 3929, 3930, 3931, 3932, 3933, 3934, 3935, 3936, 3937, 3938, 3939, 3940, 3941, 3942, 3943, 3944, 3945, 3946, 3947, 3948, 3949, 3950, 3951, 3952, 3953, 3954, 3955, 3956, 3957, 3958, 3959, 3960, 3961, 3962, 3963, 3964, 3965, 3966, 3967, 3968, 3969, 3970, 3971, 3972, 3973, 3974, 3975, 3976, 3977, 3978, 3979, 3980, 3981, 3982, 3983, 3984, 3985, 3986, 3987, 3988, 3989, 3990, 3991, 3992, 3993, 3994, 3995, 3996, 3997, 3998, 3



- b.) Sequentially view the slides by either clicking on “Prev” and “Next” buttons, or view any slide in the presentation by selecting it in the Slide Menu. Note you may review any slide at any time.



- c.) The entire text for each slide may be viewed by moving the slider directly to the right of the text frame.
- d.) Audio is provided but not essential. All the information is conveyed in the text and the main frame.

### 2. Taking the Pre-Lab Quiz

After viewing the lab session, go back to the Chemistry 2 Laboratory Presentation Home Page by clicking at the top of the page.

- a.) Click on pre-laboratory quizzes. Choose the appropriate laboratory quiz. Each pre-lab quiz must be completed at least **1 hour prior to attending your scheduled lab class**. A passing score of 100% (correct answers to all three questions) is required before you will be allowed to perform the laboratory experiment.

If you fail the quiz on the first attempt, you may take the quiz a second time. Because the questions are chosen randomly, you may receive different questions on your second attempt, so it is a good idea to review the pre-lab session prior to your second attempt. You may also view the laboratory session while you are taking the pre-laboratory quiz.

If you fail to pass the quiz on a second attempt, review the laboratory material again and be prepared to take another prelaboratory quiz at the beginning of laboratory class given by your TA but you will not receive any points.

- b.) Pre-lab quizzes are timed quizzes. You have twenty minutes to take the quiz. Furthermore, once you open a window to take a quiz, it will be counted as one of your two attempts even if you do not hit the submit button before closing the window. Only start the pre-lab quiz when you are ready to take it.
- c.) In order to receive your 2 points for the prelaboratory quiz you must complete it successfully at least 1 hour before your laboratory class is to begin.

The screenshot displays the 'Chemistry 2C' Pre-Laboratory Quizzes Menu. At the top, there is a navigation bar with links for 'Home | Logout', 'Pre-Laboratory Presentations', 'Pre-Laboratory Quizzes', 'Post-Laboratory Exercises', 'My Profile', 'Help', 'Reports', 'Admin', and 'Credits'. The main heading is 'Pre-Laboratory Quizzes Menu'. Below this, there are two columns. The left column, titled 'Select Quiz by Name', lists several quizzes: 'Redox Titrations Pre-Lab Quiz', 'Electrochemical Cells Pre-Lab Quiz', 'EDTA Titrations Pre-Lab Quiz', 'Inorganic Qualitative Analysis Pre-Lab Quiz', 'Synthesis of Coordination Compounds Pre-Lab Quiz', 'Spectrophotometric Analysis Pre-Lab Quiz', 'Kinetics Pre-Lab Quiz', and 'Vitamin C Pre-Lab Quiz'. A small note at the bottom of this list states: 'Note: Quizzes are not available with access to the prelaboratory system'. The right column, titled 'Pre-Lab Quiz Information', contains three paragraphs of text. The first paragraph states: 'Each 3-question multiple choice pre-laboratory quiz is worth 2 points and must be taken at least 1 HOUR before your scheduled laboratory class each week.' The second paragraph states: 'You have two opportunities to pass your weekly pre-lab quiz. A passing score of 100% (correct answer to all 3 questions) is required before you will be allowed to perform the laboratory experiment in class. You will receive different questions on your second opportunity, therefore, you should review the pre-laboratory presentation before creating the quiz.' The third paragraph states: 'Each of your two opportunities to pass your weekly pre-lab quiz is TIMED. You have twenty minutes to complete the quiz. Furthermore, once you open a window to take a quiz, it is counted as one of your two opportunities. EVEN IF YOU DO NOT HIT THE SUBMIT BUTTON before the window closes. ONLY START THE PRE-LAB QUIZ WHEN YOU ARE READY TO COMPLETE IT IN 20 MINUTES.' The final paragraph states: 'If you do not receive a passing score by the second attempt, review the laboratory material and be prepared to take another pre-lab quiz given by your TA at the beginning of laboratory class. In this case, you will not have earned 2 points for your pre-lab quiz.'

### 3. Completing the Post-Laboratory Exercises.

You will need to complete all the on-line post-laboratory exercises for each lab in order to receive credit for the laboratory portion of the course.

In the post-laboratory exercises, you will be asked to enter your data and the results from your calculations. For your data entries, the post-lab exercises are designed to check that your data is sensible. For example, if you are asked to weigh approximately 3 g of a substance, the program will check to see if your data entry falls within a range such as 1–6 g.

For your calculation entries, the program is designed to verify that your calculation is correct based on your previously entered data. The program also allows for rounding differences. For example, if the program is expecting the entry, 0.234, based on your data, then a value in a range of 0.232–0.236 may be accepted.

There are also multiple-choice questions and free response questions posed in the post-lab exercises. An on-line text box will be provided for you to write any concluding remarks discussing and explaining your experimental results.

- a.) Click on post-laboratory exercises. Choose the appropriate laboratory exercise and follow the instructions. See below.

## Procedures for Online Pre- & Post-Laboratory



- b.) You will need to have your laboratory notebook and a calculator or spreadsheet program to complete the exercises. You should keep a detailed record of your data entries and the resulting calculations in your laboratory notebook. You may need to reference this material when discussing a calculation with a TA.
- c.) As you proceed through your post-lab exercise, a scroll down window appears at the bottom of the screen. This summary is the post-lab data summary, and it contains your accepted entries and the number of points awarded for each question. You may refer to this summary to verify the values you entered that are used in subsequent calculations.
- d.) When asked to collect data for multiple trials, you must have data for at least 3 trials to complete the post-lab exercises. The single exception to this is Part III of the Vitamin C laboratory. When entering data or calculated values, do not include unit symbols.
- e.) In many cases, you will not be able to proceed to the next question until you have correctly answered the previous question. Some hints are provided for the first few incorrect responses. If you are unable to proceed after repeated attempts to enter a correct response, please contact your TA.
- f.) Be careful and deliberate about your entries. Once you proceed to the next question, you cannot go back and change your answer to a previous question.
- g.) In contrast to the pre-lab quizzes, you may exit the post-laboratory exercise at any time and re-enter as many times as you wish. Upon re-entry, the program will begin with the same question that you were answering when you exited. Points are not awarded until you click the submit button.

## Scoring Scheme

The first line of text on each question contains a terse notation describing the scoring for that question. The notation used and an explanation of each is provided below:

### 1. Data Entry – No Scoring

Simply enter your experimental value. The program will verify that your entry is within the expected range for the experiment, but no awarding of points is involved.

### 2. Scoring Scheme: 2-1

These are typically questions that have only two alternative answers. If you select the correct answer, you will receive two points. If you select the incorrect answer, you will receive one point for completing the question and you will be informed of the correct answer.

### 3. Scoring Scheme: 3-2-1-1

These are typically multiple-choice questions with three alternatives. If you select the correct answer on the first try, you will receive three points. The possible points earned are then reduced by one point on each try and a hint is provided. You will receive a minimum of one point if you answer correctly on the third or subsequent tries.

### 4. Scoring Scheme: 3-3-2-1

These are typically questions that require you to do calculations based upon previously entered experimental data, but may also be multiple choice questions with 4 or more alternatives. If you respond correctly on either of the first two tries, you will receive three points. The possible score is reduced by one point for each of the next two tries and remains one point for a correct response on any subsequent try.

### 5. Free Response (1 or 2 points possible)

Some of the laboratories contain questions where you will write your answer in a text box. The point value for each question will be indicated. Your TA will read your responses and award you your points accordingly. Your points for these questions will appear in your on-line score sheet.

### 6. Analysis (1 to 5 points possible)

In some of the laboratories, you will analyze a sample of unknown content. In the Redox and EDTA laboratories you will find a mass percent and in the Qualitative Analysis laboratory you will be identifying the metal ions present in a mixture. In these three laboratories, you will be awarded 1 to 5 points for accuracy. In order for the on-line program to identify which sample you were assigned to analyze, you will need to enter your locker series number.

## Due Date/Late Submission of Post-lab Exercise

The post-laboratory exercises must be completed by the next normally scheduled laboratory meeting. The last post-laboratory exercise is due the last day of instruction. Each post lab exercise has a date/time stamp to indicate the date and time of completion.

**Late submission of your post lab exercise will be met with a 5-point deduction for every calendar day it is late.**

**NOTE:** If you run into difficulty with any of your post-laboratory entries, please contact your TA.

# Chemistry Department Safety Policy

---

## U.C. Davis Department of Chemistry Chem. 2 Series

### Standard Operating Procedures

#### SAFETY RULES FOR TEACHING LABORATORIES

The following rules are designed for your safety in the laboratory. The Laboratory Instructor (LI = TA, Laboratory Supervisor, and/or Course Instructor) is required to enforce these rules and has the full backing of the Department of Chemistry Staff and Faculty. The LI is also required to enforce all laboratory experiment-specific safety procedures in carrying out the laboratory work. Violations of these rules will result in expulsion from the laboratory.

1. **No one is allowed in the laboratory without the supervision of a LI. No laboratory work will be done without supervision. Perform only authorized experiments, and only in the manner instructed. DO NOT alter experimental procedures, except as instructed.**
2. **Specific permission from your LI is required before you may work in any laboratory section other than the one to which you have been assigned.** Only laboratory rooms where the same laboratory course is operating may be used for this purpose.
3. **If you have a special health condition (asthma, pregnancy, etc.) or any personal health concerns, consult your medical professional before taking chemistry lab.**
4. **If you come to the laboratory with non-compliant goggles, shoes, or clothing, you will not be allowed to work in the laboratory. In that context, note THERE ARE NO MAKE-UP LABORATORIES.** Your course grade will be significantly lowered or you may fail the course if you do not meet the lab attire requirements.
5. **100% cotton lab coats are REQUIRED.**
6. **Approved safety goggles must be worn by all persons at all times.** At NO TIME are safety glasses of any kind acceptable in the laboratory. Safety goggles may not be modified in any manner.
7. **Clothing that completely covers the legs—including the skin between the top of the shoe and the bottom of the pant leg—must be worn at all times in the laboratory** (tights or leggings are NOT suitable leg covering). Inadequate protection often leads to injury. Avoid wearing expensive clothing to lab as it may get damaged.
8. **Closed-toe, closed-heel shoes that completely cover the entire foot must be worn at all times.**
9. **Confine long hair while in the laboratory.**
10. **Horseplay and carelessness are not permitted and are cause for expulsion from the laboratory. You are responsible for everyone's safety.**
11. **Absolutely NO food or drinks are to be stored or consumed in the laboratory.** Contact lenses and cosmetics (hand lotion, lip balm, etc.) are not to be applied and medications are not to be consumed while in the laboratory.

## Chemistry Department Safety Policy

12. Skateboards, rollerblades, and other such personal equipment must be stored outside of the laboratory. Personal electronics are only permitted when needed for the laboratory. Because cell phones or other personal electronic media can easily be damaged or contaminated in the laboratory, use of such devices is at the student's own risk.
13. **Learn the location and how to operate the nearest eyewash fountain, safety shower, fire extinguisher, and fire alarm box.** Basic first aid for any chemical splash is to wash the affected area for at least 15 minutes and seek medical attention. Use the emergency shower if appropriate, removing contaminated clothing for thorough washing. If the safety shower or eyewash is activated, the exposed person should be accompanied to the Student Health Center for further evaluation.
14. **Laboratory doors must remain closed except when individuals are actively entering or exiting the lab.**
15. **The student must have at least ONE UNGLOVED HAND when outside the laboratory.** Gloves are presumed to be contaminated and must not come into contact with anything outside the laboratory except chemical containers. Only use the **ungloved hand** to open doors, hold on to stair rails, or push elevator buttons.
16. **All activities in which toxic gases or vapors are used or produced must be carried out in the fume hood.**
17. **Mouth suction must never be used to fill pipets.**
18. **Containers of chemicals may not be taken out of the laboratory except to the dispensary for refill/replacement or to exchange full waste jugs for empty ones.** All containers must be **closed with the appropriate cap** before you take them into the hallway to the dispensary. Always use a bottle carrier when transporting chemicals and waste.
19. **Put all hazardous waste into the appropriate waste container(s) provided in your laboratory.** Do not overfill waste containers.
20. **All incidents, near misses, injuries, explosions, or fires must be reported at once to the LI.** In case of serious injury or fire (even if the fire is out), the LI or Lab Supervisor must call 911. The student must always be accompanied to the Student Health Center.
21. **Keep your working area clean – immediately clean up ALL spills or broken glassware. Dispose sharps in the appropriate container. Do not dispose pipette tips in regular trash.** Clean off your lab workbench before leaving the laboratory.

**You must sign the Safety Acknowledgement sheet before you may work in the lab. If you have questions about these rules and procedures, please ask your LI before starting any laboratory work in this course.**



# Safety in the Chemistry 2 Laboratories

---

Students are an integral part of accident and injury prevention effort. The laboratory safety rules require the students to follow Safe Laboratory Practices and wear the proper **Personal Protective Equipment (PPE)**.

## Safe Laboratory Practices

Using safe laboratory practices prevents most accidents and injuries from occurring. Remember that you are sharing the same work area with 23 other students. Any unsafe practices on the part of your fellow students may end up injuring you or others. Courteously correct unsafe lab practices you may encounter or report them to your TA. Laboratory safety is a communal effort.

### 1. Work Under Supervision

Your TA must be present to supervise all experiments. If your TA is incapacitated, contact dispensary staff immediately.

Report all accidents and injuries to your TA, no matter how small.

### 2. Follow Instructions

The Chemistry 2 laboratory is designed to minimize the hazard exposure to students. Failure to follow the lab manual instructions may result in accidents and injuries to you and others around you.

Always follow the manual unless directly instructed by your Laboratory Instructor or the teaching lab staff.

Follow all instructions posted in the laboratory.

### 3. Safety Equipment

There are many safety types of equipment in the Chemistry 2 laboratory. Learn where they are and how to operate them.

- **Exits**

The ability to remove yourself from a dangerous situation is one of the most important safety skills you have.

**Keep the exits clear.** Do not block exits with backpacks, skateboards, bicycles, etc.

**Keep the doors closed.** Do not prop the door open.

- **Fire Extinguisher**

Learn the location of the fire extinguisher. It is usually placed next to an exit.

## Safety in the Chemistry 2 Laboratories

- **Eyewash**

Learn the location of the eyewash. For chemical spills in your eyes, use the Eyewash fountain. Hold your eyelids open and wash affected area water for 15 minutes with water. Seek medical attention.

- **Drenching Hose and Safety Shower**

Learn the location of the drench hose and safety shower.

For large spills on your body, use the **safety shower**.

- Remove contaminated clothing and wash affected area with water. Seek medical attention immediately.
- When the safety shower is used, all other students must evacuate the room.

The TA **must** dial 911 and inform the Fire Department that the safety shower is used.

For small chemical spills on your arms and hands, use the **drench hose**.

- Wash affected area water for 15 minutes with water and contact your TA. You may also use the tap water faucet if it is adequate for washing the affected area. It is advised that you seek medical attention for even minor burns.

- **Fire Alarm Box**

The fire alarm boxes in the Science Lab building are located in the hallway.

#### 4. Practice Good Housekeeping

Keep work area organized. Don't put glassware on edges where they may fall off.

Cap all bottles and close all drawers immediately.

Clean up all spills and broken glassware immediately.

#### 5. Avoid Chemical Contamination

Do not bring food and drinks into labs.

Do not consume or use food, beverage, medicine, chewing gum, or tobacco, apply makeup or contact lenses in the laboratory.

Take off one glove when leaving the laboratory. Do not touch anything outside the laboratory with your laboratory gloves.

Wash your hands thoroughly before leaving the lab.

## Personal Protective Equipment (PPE)

Students must come to the laboratory section with the appropriate personal protective equipment. The PPE is the last line of defense against chemical hazards in the laboratory. Failure to don the appropriate PPE will result in your removal from the laboratory. Many students may find it helpful to keep a bag dedicated to chemistry lab courses with the proper clothing and PPE and change into them before class.

### 1. Dress Code

Clothing worn in the laboratory should be able to protect you from small splashes and spills of liquids. For the Chemistry 2 laboratories, students are required to have long sleeves, long pants, and shoes that cover the entirety of the foot.

- **Long sleeve shirt and long pants:**

You must wear clothing that covers your arms, legs, wrists and ankles to protect you from small spills. Long skirts, tights or leggings do not qualify. Do not wear clothing with holes in them as they will not protect you from spills.

- **Shoes that cover the entirety of the foot and socks to cover the ankles:**

You must wear closed-toe, closed-heeled shoes that completely cover your foot. Do not wear sandals, slippers, or shoes that expose the back of your foot. Broken glassware and spilled chemicals are more likely to land on your foot than anywhere else. Also remember to wear socks to cover your ankles. The area between your shoes and pants should not be exposed when you are seated.

A good rule of thumb to keep in mind is: **No skin exposure from the neck down to the feet in the laboratory.**

### 2. Goggles

Lab goggles are designed to protect your eyes. Injury to the eyes is often irreversible and may severely impact your future. Always wear approved goggles when working in the laboratory.

- **Approved Goggles**

ANSI Z87.1-compliant chemical splash goggles with indirect venting is required for the Chemistry 2 course. Approved lab goggles may be purchased at the MU Bookstore, the Silo Bookstore or the ARC Pro Shop in the Activity and Recreation Center.

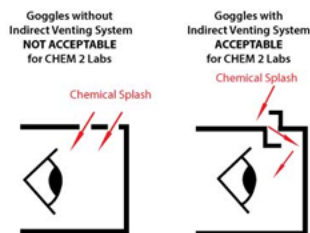

- **Goggles Rules**

Modified goggles will not be allowed in the lab. Do not modify the goggles by adjusting or removing the indirect venting system.

Goggles strap must be adjusted to fit properly at all times.

**Never** take off your goggles in the laboratory. If you need to adjust your goggles or if they fog up, leave the laboratory and return when your goggles issues are resolved.

### 3. Lab Coat

You must provide your own lab coat for all chemistry lab courses. Only wear lab coats during the laboratory. Take off your lab coat immediately after lab. Do not wear lab coat outside the laboratory.

Your lab coat must be made of 100% cotton. Disposable, synthetic lab coats are not acceptable.

Your lab coat must be properly fitted so that it protects your arms and body. The sleeves of your lab coat must fully extend to the wrists. Do not wear a lab coat that's too small or too big for you.

Keep your lab coat buttoned at all times.

### 4. Gloves

You will be provided with disposable nitrile gloves in lab for your protection. Do not bring your own gloves.

Wear gloves when handling hazardous chemicals or contacting potentially contaminated surfaces.

Never re-use disposable gloves. **Remove and replace contaminated nitrile gloves immediately.**

- **Allergy**

If you are allergic to nitrile gloves, contact your TA and the laboratory staff. You will be provided with hypoallergenic lab gloves.

- **Fit**

Make sure you wear the correct sized gloves. Gloves that are too large for your hand greatly increase the likelihood of accidents.

# Maps and Emergency Evacuation Procedures

## **1. Prior to Exiting**

After being notified to evacuate, cease all work activities and evacuate immediately.

Stop all reactions and turn off all sources of ignition.

Close, but do not lock, the doors. Take your purse, briefcase, backpack and keys with you if possible. Remember that you may not be allowed back into the building for an extended time.

## **2. Evacuation Routes/Exiting the Building**

During an emergency evacuation, use the nearest door or stairway if available to exit the building. Do not use elevators for fire/earthquake evacuations.

Be aware of at least two exit routes in the event one is compromised.

## **3. Assembly Area**

After exiting the building, all occupants should follow the evacuation route to the pre-arranged assembly area.

**DO NOT** return to the building until notified by emergency personnel. Supervisors must take roll to ensure all occupants have safely evacuated the building.

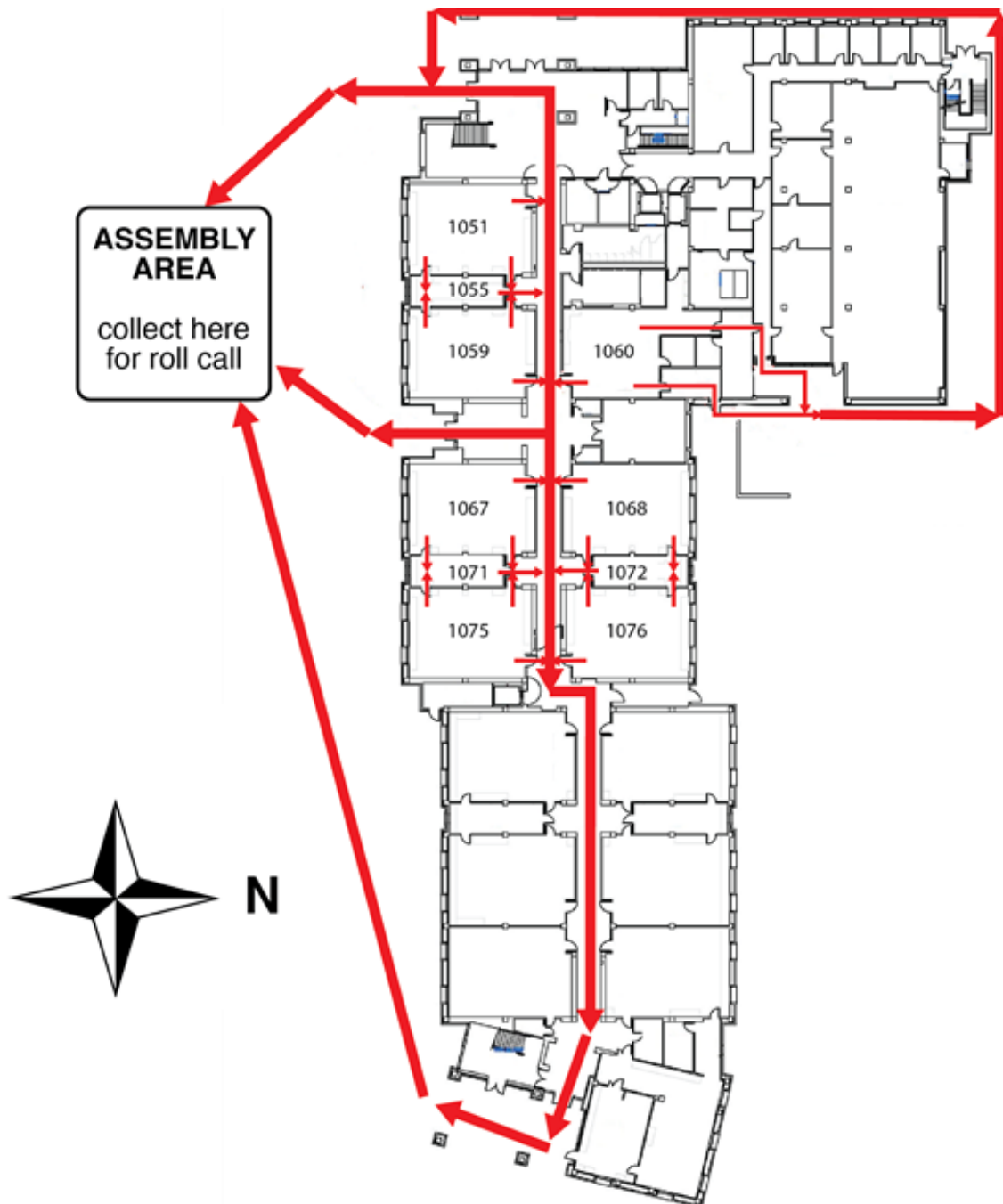

Figure 1. Evacuation routes for the 1st floor SLB rooms.





Figure 3. The assembly area for Chemistry 2 students and personnel.



# General Emergency Procedures

---

The following are some general instructions for actions to take in case of an emergency:

## 1. Medical Emergency

- 1) Remain calm.
- 2) Initiate lifesaving measures if required.
- 3) TA will call for the dispensary supervisor and/or for Emergency Response—CALL 911.
- 4) Do not move injured persons unless it is necessary to prevent further harm.
- 5) Keep injured person warm.

## 2. Major Incident

- 1) Alert TA to injured or contaminates persons.
- 2) Alert people to evacuate the area.
- 3) TA will call for the dispensary supervisor and/or Emergency Response—CALL 911.

**Fire**.....911

**Chemical, radiation, biological spill**.....911

**(Evenings and Weekends)**.....911

- 4) Close doors to affected areas.
- 5) Have person knowledgeable of incident inform the TA.

## 3. Fire Alarm

- 1) When fire alarm sounds, evacuate the room and follow evacuation plan to the Assembly Area. The Assembly Area is on the south side of the large tree, which is on the west side of the Sciences Lab Building.
- 2) TAs must take roll to ensure all students are accounted for.
- 3) If the building is cleared, you will return to continue your lab.

# Dispensary Procedures

---

## 1. Dispensary Location and Policies

The CHE2 dispensary is located on the first floor of the SLB in **Room 1060**. Go to the **dispensary roll-up window (1060E)** for service.

You must wear the proper PPE to the dispensary. This includes your **lab coat and goggles**. Remember that you should have at least **one ungloved hand** while outside your laboratory.

## 2. Dispensing Policies

### a.) Policies at the Beginning of the Quarter

**Goggles and Lab Coat:** You are required to provide your own goggles and lab coats.

**Locker Supplies:** It is required that you do a locker inventory during the first week of labs. Make sure that you have everything on your locker list by the end of the second week of instruction.

### b.) Policies During the Quarter

**Locker Supplies:** If a locker item is broken after the initial two-week period, go to the dispensary to request a replacement. You must know the exact name and specification of the item to be replaced.

**Refilling of Chemical and Supply Containers:** When replacing or refilling general laboratory chemicals or supplies, be sure to bring the empty containers to the dispensary. Be sure all containers are closed with the correct cap and placed in the correct bottle carrier.

To avoid chemical contamination and equipment breakage, please refrain from bringing personal bags and backpacks to dispensary window when seeking replacement chemical containers or lab equipment.

**Waste Containers:** Call the dispensary for replacements when waste containers are full.

### c.) Policies at the End of the Quarter

**Surplus Stores:** Any item you may have in surplus should be placed in the area set aside for surplus items in the laboratory (a box at the back of the lab).

**Filling Locker Requirements:** If your locker is short of any items when you are checking your locker equipment against your locker list, obtain the missing items from the surplus items in the laboratory. If the missing item is not in the surplus area, obtain it from the dispensary.

**Preparing Your Locker for Check-Out:** Clean and quickly dry all equipment. Replace all broken or missing items by checking them out from the dispensary. Return all extra equipment to the extra glassware box in the lab. Have your TA check the contents of the locker and if everything is present and clean then they will lock the drawer.

# Safety Data Sheet

---

The Safety Data Sheet (SDS) is a document that provides information to enable users of a substance or mixture to take the necessary measures relating to protection of health and safety at the workplace, and the protection of the environment. A Safety Data Sheet has the following sections:

1. Identification;
2. Hazard identification;
3. Composition/information on ingredients;
4. First-aid measures;
5. Fire-fighting measures;
6. Accidental release measures;
7. Handling and storage;
8. Exposure controls/personal protection;
9. Physical and chemical properties;
10. Stability and reactivity;
11. Toxicological information;
12. Ecological information;
13. Disposal considerations;
14. Transport information;
15. Regulatory information;
16. Other information.

A list of SDS resources may be found at: <http://ehs.ucop.edu/sds>

The following pages show a sample SDS for the **6M Hydrochloric Acid** commonly used in the CHE2 laboratory courses.



# Fisher Scientific

Part of Thermo Fisher Scientific

## SAFETY DATA SHEET

Creation Date 24-Aug-2009

Revision Date 24-Feb-2014

Revision Number 1

### 1. Identification

**Product Name** Hydrochloric Acid Solution, 6N (Certified)

**Cat No. :** SA56-1; SA56-4; SA56-200; SA56-500

**Synonyms** Chlorohydric acid; Hydrogen chloride solution.; Muriatic acid

**Recommended Use** Laboratory chemicals.

**Uses advised against** No Information available

**Details of the supplier of the safety data sheet**

**Company**

Fisher Scientific  
One Reagent Lane  
Fair Lawn, NJ 07410  
Tel: (201) 796-7100

**Emergency Telephone Number**

CHEMTREC®, Inside the USA: 800-424-9300  
CHEMTREC®, Outside the USA: 001-703-527-3887

### 2. Hazard(s) identification

**Classification**

This chemical is considered hazardous by the 2012 OSHA Hazard Communication Standard (29 CFR 1910.1200)

Corrosive to metals	Category 1
Skin Corrosion/Irritation	Category 1 B
Serious Eye Damage/Eye Irritation	Category 1
Specific target organ toxicity (single exposure)	Category 3
Target Organs - Respiratory system.	

**Label Elements**

**Signal Word**

Danger

**Hazard Statements**

May be corrosive to metals  
Causes severe skin burns and eye damage  
May cause respiratory irritation

**Precautionary Statements****Prevention**

Do not breathe dust/fume/gas/mist/vapors/spray  
 Wash face, hands and any exposed skin thoroughly after handling  
 Wear protective gloves/protective clothing/eye protection/face protection  
 Use only outdoors or in a well-ventilated area  
 Keep only in original container

**Response**

Immediately call a POISON CENTER or doctor/physician

**Inhalation**

IF INHALED: Remove victim to fresh air and keep at rest in a position comfortable for breathing

**Skin**

IF ON SKIN (or hair): Take off immediately all contaminated clothing. Rinse skin with water/shower  
 Wash contaminated clothing before reuse

**Eyes**

IF IN EYES: Rinse cautiously with water for several minutes. Remove contact lenses, if present and easy to do. Continue rinsing

**Ingestion**

IF SWALLOWED: Rinse mouth. DO NOT induce vomiting

**Spills**

Absorb spillage to prevent material damage

**Storage**

Store locked up  
 Store in a well-ventilated place. Keep container tightly closed  
 Store in corrosive resistant polypropylene container with a resistant inliner  
 Store in a dry place

**Disposal**

Dispose of contents/container to an approved waste disposal plant

**Hazards not otherwise classified (HNOC)**

None identified

### 3. Composition / information on ingredients

Component	CAS-No	Weight %
Water	7732-18-5	>78
Hydrochloric acid	7647-01-0	22

### 4. First-aid measures

**General Advice**

If symptoms persist, call a physician.

**Eye Contact**

Rinse immediately with plenty of water, also under the eyelids, for at least 15 minutes. Immediate medical attention is required.

**Skin Contact**

Wash off immediately with plenty of water for at least 15 minutes. Immediate medical attention is required.

**Inhalation**

Move to fresh air. If breathing is difficult, give oxygen. Do not use mouth-to-mouth method if victim ingested or inhaled the substance; give artificial respiration with the aid of a pocket mask equipped with a one-way valve or other proper respiratory medical device. Immediate

medical attention is required.

**Ingestion**

Do not induce vomiting. Call a physician or Poison Control Center immediately.

**Most important symptoms/effects**

Causes burns by all exposure routes. Product is a corrosive material. Use of gastric lavage or emesis is contraindicated. Possible perforation of stomach or esophagus should be investigated: Ingestion causes severe swelling, severe damage to the delicate tissue and danger of perforation

**Notes to Physician**

Treat symptomatically

## 5. Fire-fighting measures

**Suitable Extinguishing Media**

Substance is nonflammable; use agent most appropriate to extinguish surrounding fire.

**Unsuitable Extinguishing Media**

No information available

**Flash Point Method -**

No information available

No information available

**Autoignition Temperature**

No information available

**Explosion Limits****Upper**

No data available

**Lower**

No data available

**Sensitivity to Mechanical Impact**

No information available

**Sensitivity to Static Discharge**

No information available

**Specific Hazards Arising from the Chemical**

Non-combustible, substance itself does not burn but may decompose upon heating to produce corrosive and/or toxic fumes.

**Hazardous Combustion Products**

Hydrogen chloride gas Carbon monoxide (CO) Carbon dioxide (CO<sub>2</sub>) Hydrogen

**Protective Equipment and Precautions for Firefighters**

As in any fire, wear self-contained breathing apparatus pressure-demand, MSHA/NIOSH (approved or equivalent) and full protective gear.

**NFPA**

**Health**  
3

**Flammability**  
0

**Instability**  
1

**Physical hazards**  
N/A

## 6. Accidental release measures

**Personal Precautions**

Use personal protective equipment. Ensure adequate ventilation. Evacuate personnel to safe areas.

**Environmental Precautions**

Should not be released into the environment. See Section 12 for additional ecological information.

**Methods for Containment and Clean Up**

Soak up with inert absorbent material. Keep in suitable, closed containers for disposal.

## 7. Handling and storage

**Handling**

Use only under a chemical fume hood. Ensure adequate ventilation. Wear personal protective equipment. Do not get in eyes, on skin, or on clothing. Do not breathe vapors or spray mist. Do not ingest.

**Storage**

Keep containers tightly closed in a dry, cool and well-ventilated place.

## 8. Exposure controls / personal protection

**Exposure Guidelines**

Component	ACGIH TLV	OSHA PEL	NIOSH IDLH
Hydrochloric acid	Ceiling: 2 ppm	Ceiling: 5 ppm Ceiling: 7 mg/m <sup>3</sup> (Vacated) Ceiling: 5 ppm (Vacated) Ceiling: 7 mg/m <sup>3</sup>	IDLH: 50 ppm Ceiling: 5 ppm Ceiling: 7 mg/m <sup>3</sup>

Component	Quebec	Mexico OEL (TWA)	Ontario TWAEV
Hydrochloric acid	Ceiling: 5 ppm Ceiling: 7.5 mg/m <sup>3</sup>	Ceiling: 5 ppm Ceiling: 7 mg/m <sup>3</sup>	CEV: 2 ppm

**Legend**

**ACGIH** - American Conference of Governmental Industrial Hygienists

**OSHA** - Occupational Safety and Health Administration

**NIOSH IDLH**: The National Institute for Occupational Safety and Health Immediately Dangerous to Life or Health

**Engineering Measures**

Use only under a chemical fume hood. Ensure that eyewash stations and safety showers are close to the workstation location.

**Personal Protective Equipment****Eye/face Protection**

Wear appropriate protective eyeglasses or chemical safety goggles as described by OSHA's eye and face protection regulations in 29 CFR 1910.133 or European Standard EN166.

**Skin and body protection**

Wear appropriate protective gloves and clothing to prevent skin exposure.

**Respiratory Protection**

Follow the OSHA respirator regulations found in 29 CFR 1910.134 or European Standard EN 149. Use a NIOSH/MSHA or European Standard EN 149 approved respirator if exposure limits are exceeded or if irritation or other symptoms are experienced.

**Hygiene Measures**

Handle in accordance with good industrial hygiene and safety practice.

## 9. Physical and chemical properties

<b>Physical State</b>	Liquid
<b>Appearance</b>	Clear
<b>Odor</b>	pungent
<b>Odor Threshold</b>	No information available
<b>pH</b>	1
<b>Melting Point/Range</b>	-74 °C / -101.2 °F
<b>Boiling Point/Range</b>	81.5 - 110 °C / 178.7 - 230 °F @ 760 mmHg
<b>Flash Point</b>	No information available
<b>Evaporation Rate</b>	> 1.00 (Butyl Acetate = 1.0)
<b>Flammability (solid,gas)</b>	Not applicable
<b>Flammability or explosive limits</b>	
<b>Upper</b>	No data available
<b>Lower</b>	No data available
<b>Vapor Pressure</b>	5.7 mmHg @ 0 °C
<b>Vapor Density</b>	1.26
<b>Specific Gravity</b>	1.0 - 1.2
<b>Solubility</b>	Miscible with water
<b>Partition coefficient; n-octanol/water</b>	No data available
<b>Autoignition Temperature</b>	No information available
<b>Decomposition Temperature</b>	No information available
<b>Viscosity</b>	No information available

## 10. Stability and reactivity

<b>Reactive Hazard</b>	None known, based on information available
<b>Stability</b>	Stable under normal conditions. Water reactive.
<b>Conditions to Avoid</b>	Incompatible products. Excess heat. Exposure to moist air or water.
<b>Incompatible Materials</b>	Metals, Oxidizing agents, Reducing agents, Acids, Bases, Aldehydes
<b>Hazardous Decomposition Products</b>	Hydrogen chloride gas, Carbon monoxide (CO), Carbon dioxide (CO <sub>2</sub> ), Hydrogen
<b>Hazardous Polymerization</b>	Hazardous polymerization does not occur.
<b>Hazardous Reactions</b>	May react with metals and lead to the formation of flammable hydrogen gas. Corrosive to metals.

## 11. Toxicological information

### Acute Toxicity

#### Product Information

##### Oral LD50

Based on ATE data, the classification criteria are not met. ATE > 2000 mg/kg.

##### Dermal LD50

Based on ATE data, the classification criteria are not met. ATE > 2000 mg/kg.

##### Vapor LC50

Based on ATE data, the classification criteria are not met. ATE > 20 mg/l.

#### Component Information

Component	LD50 Oral	LD50 Dermal	LC50 Inhalation
Water	-	Not listed	Not listed
Hydrochloric acid	LD50 238 - 277 mg/kg ( Rat )	LD50 > 5010 mg/kg ( Rabbit )	LC50 = 1.68 mg/L ( Rat ) 1 h

**Toxicologically Synergistic Products** No information available

### Delayed and immediate effects as well as chronic effects from short and long-term exposure

**Irritation** Causes burns by all exposure routes

**Sensitization** No information available

**Carcinogenicity** The table below indicates whether each agency has listed any ingredient as a carcinogen.

Component	CAS-No	IARC	NTP	ACGIH	OSHA	Mexico
Water	7732-18-5	Not listed	Not listed	Not listed	Not listed	Not listed
Hydrochloric acid	7647-01-0	Not listed	Not listed	Not listed	Not listed	Not listed

**Mutagenic Effects** No information available

**Reproductive Effects** No information available.

**Developmental Effects** No information available.

**Teratogenicity** No information available.

**STOT - single exposure** Respiratory system

**STOT - repeated exposure** None known

**Aspiration hazard** No information available

**Symptoms / effects, both acute and delayed** Product is a corrosive material. Use of gastric lavage or emesis is contraindicated. Possible perforation of stomach or esophagus should be investigated: Ingestion causes severe swelling, severe damage to the delicate tissue and danger of perforation

**Endocrine Disruptor Information** No information available

**Other Adverse Effects** The toxicological properties have not been fully investigated.



## 12. Ecological information

### Ecotoxicity

Do not empty into drains.

Component	Freshwater Algae	Freshwater Fish	Microtox	Water Flea
Hydrochloric acid	-	282 mg/L LC50 96 h	-	-

**Persistence and Degradability** Persistence is unlikely based on information available.

**Bioaccumulation/ Accumulation** No information available.

**Mobility** No information available.

## 13. Disposal considerations

**Waste Disposal Methods** Chemical waste generators must determine whether a discarded chemical is classified as a hazardous waste. Chemical waste generators must also consult local, regional, and national hazardous waste regulations to ensure complete and accurate classification.

## 14. Transport information

### DOT

UN-No UN1789  
 Proper Shipping Name HYDROCHLORIC ACID SOLUTION  
 Hazard Class 8  
 Packing Group II

### TDG

UN-No UN1789  
 Proper Shipping Name HYDROCHLORIC ACID SOLUTION  
 Hazard Class 8  
 Packing Group II

### IATA

UN-No UN1789  
 Proper Shipping Name HYDROCHLORIC ACID SOLUTION  
 Hazard Class 8  
 Packing Group II

### IMDG/IMO

UN-No UN1789  
 Proper Shipping Name HYDROCHLORIC ACID, SOLUTION  
 Hazard Class 8  
 Packing Group II

## 15. Regulatory information

### International Inventories

Component	TSCA	DSL	NDSL	EINECS	ELINCS	NLP	PICCS	ENCS	AICS	IECSC	KECL
Water	X	X	-	231-791-2	-		X	-	X	X	X
Hydrochloric acid	X	X	-	231-595-7	-		X	X	X	X	X

#### Legend:

X - Listed

E - Indicates a substance that is the subject of a Section 5(e) Consent order under TSCA.

F - Indicates a substance that is the subject of a Section 5(f) Rule under TSCA.

N - Indicates a polymeric substance containing no free-radical initiator in its inventory name but is considered to cover the designated polymer made with any free-radical initiator regardless of the amount used.

P - Indicates a commenced PMN substance

R - Indicates a substance that is the subject of a Section 6 risk management rule under TSCA.

S - Indicates a substance that is identified in a proposed or final Significant New Use Rule

T - Indicates a substance that is the subject of a Section 4 test rule under TSCA.

XU - Indicates a substance exempt from reporting under the Inventory Update Rule, i.e. Partial Updating of the TSCA Inventory Data Base Production and Site Reports (40 CFR 710(B)).

Y1 - Indicates an exempt polymer that has a number-average molecular weight of 1,000 or greater.

Y2 - Indicates an exempt polymer that is a polyester and is made only from reactants included in a specified list of low concern reactants that comprises one of the eligibility criteria for the exemption rule.

**Sample - Safety Data Sheet**

Hydrochloric Acid Solution, 6N (Certified)

Revision Date 24-Feb-2014

**U.S. Federal Regulations**

TSCA 12(b) Not applicable

**SARA 313**

Component	CAS-No	Weight %	SARA 313 - Threshold Values %
Hydrochloric acid	7647-01-0	22	1.0

**SARA 311/312 Hazard Categories**

Acute Health Hazard	Yes
Chronic Health Hazard	No
Fire Hazard	No
Sudden Release of Pressure Hazard	No
Reactive Hazard	No

**CWA (Clean Water Act)**

Component	CWA - Hazardous Substances	CWA - Reportable Quantities	CWA - Toxic Pollutants	CWA - Priority Pollutants
Hydrochloric acid	X	5000 lb	-	-

**Clean Air Act**

Component	HAPS Data	Class 1 Ozone Depletors	Class 2 Ozone Depletors
Hydrochloric acid	X		-

**OSHA Occupational Safety and Health Administration**

Not applicable

Component	Specifically Regulated Chemicals	Highly Hazardous Chemicals
Hydrochloric acid	-	TQ: 5000 lb

**CERCLA**

Component	Hazardous Substances RQs	CERCLA EHS RQs
Hydrochloric acid	5000 lb	5000 lb

**California Proposition 65** This product does not contain any Proposition 65 chemicals**U.S. State Right-to-Know Regulations**

Component	Massachusetts	New Jersey	Pennsylvania	Illinois	Rhode Island
Water	-	-	X	-	-
Hydrochloric acid	X	X	X	X	X

**U.S. Department of Transportation**

Reportable Quantity (RQ):	N
DOT Marine Pollutant	N
DOT Severe Marine Pollutant	N

**U.S. Department of Homeland Security**

This product contains the following DHS chemicals:

Component	DHS Chemical Facility Anti-Terrorism Standard
Hydrochloric acid	0 lb STQ (anhydrous); 11250 lb STQ (37% concentration or greater)

**Other International Regulations****Mexico - Grade** No information available

**Canada**

This product has been classified in accordance with the hazard criteria of the Controlled Products Regulations (CPR) and the MSDS contains all the information required by the CPR

WHMIS Hazard Class

E Corrosive material

**16. Other information**

Prepared By

Regulatory Affairs  
Thermo Fisher Scientific  
Email: EMSDS.RA@thermofisher.com

Creation Date

24-Aug-2009

Revision Date

24-Feb-2014

Print Date

24-Feb-2014

Revision Summary

This document has been updated to comply with the US OSHA HazCom 2012 Standard replacing the current legislation under 29 CFR 1910.1200 to align with the Globally Harmonized System of Classification and Labeling of Chemicals (GHS)

**Disclaimer**

The information provided in this Safety Data Sheet is correct to the best of our knowledge, information and belief at the date of its publication. The information given is designed only as a guidance for safe handling, use, processing, storage, transportation, disposal and release and is not to be considered a warranty or quality specification. The information relates only to the specific material designated and may not be valid for such material used in combination with any other materials or in any process, unless specified in the text

**End of SDS**

# Hazardous Chemicals

---

## Hazardous Chemicals

The laboratory is a chemical use area for potentially hazardous compounds. The following are the hazard classes of chemicals used in this course and for which this laboratory is designated as a use area:

1. **Acutely Toxic Solids and Liquids**
2. **Carcinogens**
3. **Corrosives**
4. **Flammable and combustible liquids**
5. **Flammable solids**
6. **Reproductive Toxins**

## Hazardous Waste

**Cation Metal Waste:** Label is **WHITE** and is used in all CHEM 2 courses.

<b>DO NOT FILL ABOVE THIS LINE</b>	
<b>HAZARDOUS WASTE</b> Chem 2 Experiment <b>Cation Metal Waste</b>	
<b>Follow these instructions:</b> <ul style="list-style-type: none"><li>➤ Cap lid when not in use</li><li>➤ Leave in fume hood</li><li>➤ Call Dispensary when full</li></ul>	
<b>FOR WASTE ONLY</b>	<b>Chemical Waste Composition:</b> Aluminum, Bismuth, Chromium, Cobalt, Copper, Iron, Lead, Manganese, Silver, Zinc,
<b>DANGER</b>	
	

**Organic Mixture Waste:** Label is **YELLOW** and is used only in CHEM 2B.

**DO NOT LEAVE BOTTLE UNCAPPED  
DO NOT REMOVE FROM FUMEHOOD  
CALL DISPENSARY WHEN FULL**

**HAZARDOUS WASTE**

Chem 2B Experiment

**Colligative Properties**

Chemical Waste Composition:

**Cyclohexane, Acetone,**

**p-Dibromobeneze,**

**p-Dichlorobenzene,**

**Naphthalene, Diphenyl,**

**Benzophenone,**



**WASTE ONLY**

**DO NOT LEAVE BOTTLE UNCAPPED**

**--FLAMMABLE--**



**Dithizone in Chloroform Waste:** Label is **BLUE** and is used only in CHEM 2C.

<p><b>KEEP BOTTLE UNCAPPED DO NOT REMOVE FROM FUMEHOOD CALL DISPENSARY WHEN FULL</b></p>
<p><b>HAZARDOUS WASTE</b> Chem 2C Experiment <b>Qualitative Analysis</b></p>
<p>Chemical Waste Composition: <b>Chloroform, Acetone, Dithizone,</b></p>
<p><b>WASTE ONLY</b> DO NOT LEAVE BOTTLE UNCAPPED <i>-Flammable- Toxic</i></p> <p> </p>

# Statistical Treatment of Data

---

Every measurement made in the laboratory is subject to error. Although you should try to minimize error, two types of errors will occur. Systematic or Determinate Errors are those errors which are reproducible and which can be corrected. Examples are errors due to a mis-calibrated piece of glassware or a balance that consistently weighs light. Random or Indeterminate Errors are due to limitations of measurement that are beyond the experimenter's control. These errors cannot be eliminated and lead to both positive and negative fluctuations in successive measurements. Examples are a difference in readings by different observers, or the fluctuations in equipment due to electrical noise.

You will be graded by your ability to obtain accurate results. Accuracy describes how close your result is to the true value. Another related term is precision. Precision describes how close your results from different trials are to each other. Data of high precision indicates small random errors and leads experimenters to have confidence in their results. Data that is highly accurate suggests that there is little systematic error. A well-designed experiment (and a well-trained experimenter) should yield data that is both precise and accurate.

In an effort to describe and quantify the random errors which will occur during the course of the Chemistry 2 laboratory you will be asked to report an average, a standard deviation, a 90% confidence limit, and a relative deviation. You may also have to analyze multiple trials to decide whether or not a certain piece of data should be discarded. The following sections describe these procedures.

## 1. Average and Standard Deviation

The average or mean,  $x$ , is defined by

$$x = \frac{\sum x_i}{N}$$

where each  $x_i$  is one measurement and  $N$  is the number of trials or samples.

The standard deviation,  $\sigma$ , measures how close values are clustered about the mean. The standard deviation for small samples is defined by

$$\sigma = \sqrt{\frac{\sum (x_i - x)^2}{N - 1}}$$

The smaller the value of  $\sigma$ , the more closely packed the data is about the mean—or, in other words, the measurements are more precise.



## 2. Confidence Limits

Confidence limits provide an indication of data precision. For example, a 90% confidence limit of  $\pm 2.0$  indicates that there is a 90% probability that the true average of an infinite collection of data is within  $\pm 2.0$  of the calculated average of a limited collection. Clearly, the more precise a set of data, the smaller the confidence interval. Thus, a small confidence interval is always the goal of any experiment. In General Chemistry, you will be required to calculate the 90% confidence interval for all experimental collections of data. The formula to do this is:

$$\text{Confidence Limit} = \frac{t \cdot \sigma}{\sqrt{N}}$$

where  $t$  varies with the number of observations. For the 90% confidence limits, you are asked to calculate:

Number of Trials (N)	$t$
2	6.314
3	2.92
4	2.353
5	2.132
6	2.015

You should always report your result as the average  $\pm$  the 90% confidence limit.

## 3. Relative Deviation

The relative average deviation,  $d$ , like the standard deviation, is useful to determine how data are clustered about a mean. The advantage of a relative deviation is that it incorporates the relative numerical magnitude of the average.

The relative average deviation,  $d$ , is calculated in the following way.

- Calculate the average,  $x$ , with all data that are of high quality.
- Calculate the deviation,  $|x_i - x|$ , of each good piece of data.
- Calculate the average of these deviations.
- Divide that average of the deviations by the mean of the good data.

This number is generally expressed as parts per thousand (ppt). You can do this by simply multiplying by 1000.

Please report the relative average deviation (ppt) in addition to the standard deviation in all experiments.

### 4. Analysis of Poor Data: Q-test

Sometimes a single piece of data is inconsistent with other data. You need a method to determine, or test, if the data in question is so poor that it should be excluded from your calculations. Many tests have been developed for this purpose. One of the most common is what is known as the Q-test. To determine if a data should be discarded by this test you first need to calculate the difference of the data in question from the data closest in value (this is called the “gap”). Next, you calculate the magnitude of the total spread of the data by calculating the difference between the data in question and the data furthest away in value (this is called the “range”). You will then calculate the  $Q_{Data}$ , given by

$$Q_{Data} = \frac{gap}{range}$$

and compare the value to that given in the table below. The values in the table below are given for the 90% confidence level. If the  $Q_{Data}$  is greater than the  $Q_{Critical}$  then the data can be discarded with 90% confidence (the value has a less than 10% chance of being valid).

Number of Trials	$Q_{Critical}$
3	0.94
4	0.76
5	0.64
6	0.56

While the Q test is very popular, it is not always useful for the small samples you will have (you will generally only do triplicate trials).

Keep in mind that you also always have the right to discard a piece of data that you are sure is of low quality. That is, when you are aware of a poor collection. However, beware of discarding data that do not meet the Q test. You may be discarding your most accurate determination!

# An Introduction to Excel

In chemistry, as well as in other analytical sciences, it is important to not only know how to collect quality data, but also know how to analyze and manipulate that data to investigate your hypothesis. A spreadsheet program, such as Microsoft Excel, is an especially helpful tool to use for viewing and manipulating data, as it can be used to quickly perform complex calculations on large sets of data, as well as to rearrange raw data into easy to understand graphical representations.

In this guide, you will learn how to create a basic spreadsheet in Excel, and use formulas to quickly perform calculations on your data. You will also learn how to make graphs for your post-lab reports.

This guide uses Microsoft Excel 2016, which is available as a free download for students via:

► <http://officedownload.ucdavis.edu>

The above link can be accessed by logging in with your campus Kerberos (CAS) account. If you do not wish to download Microsoft Office onto your personal computer, Excel is also available for use at all of the computer labs on campus.

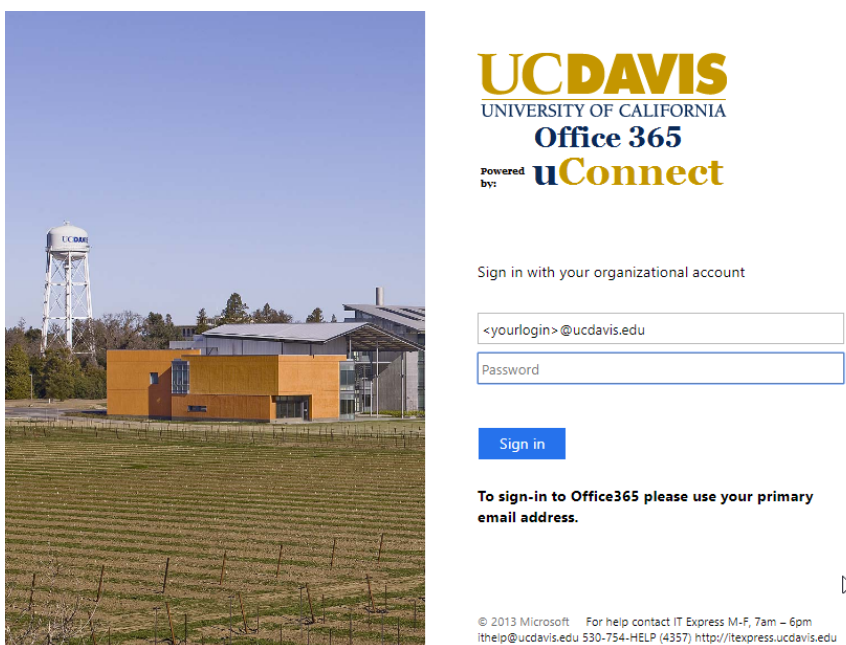

Figure 1. Use your UC Davis login information to access Microsoft Office 365.

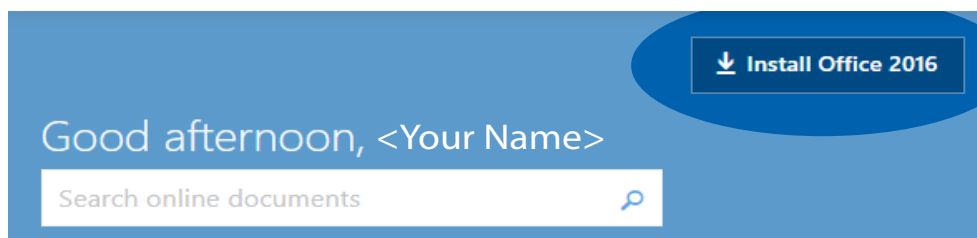
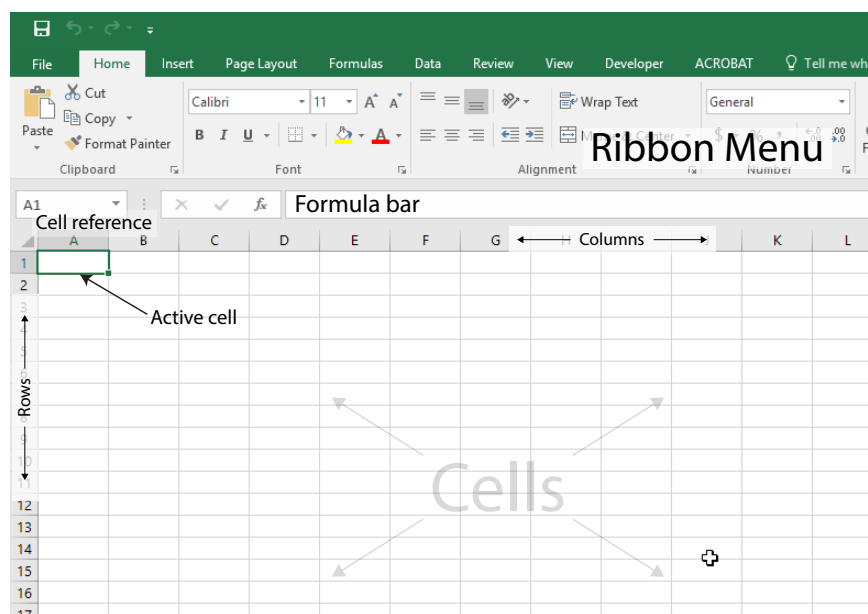

Figure 2. You can install Microsoft Office 2016 by clicking on the “Install Office 2016” button once you’ve logged in.

## Excel Basics

1. Open a new spreadsheet in Excel 2016. The image below shows a section of the blank worksheet.



**Figure 3.** A blank spreadsheet in Excel 2016.

The gray rectangles that make up the spreadsheet are called **cells**, and the **active cell**, or the cell you are currently typing in, has a green outline around it with a handle at the bottom right.

Each cell has its own **cell reference** that consists of the letter of the column and the number of the row it is currently in. The cell reference is analogous to a variable in algebra, where the reference refers to the data inside of the cell. In the image above, the cell reference of the active cell is **A1**.

The **formula bar** displays the formulas in the active cell. If there are no formulas in the active cell, the formula bar displays the text in the cell.

The **ribbon menu** contains a variety of commands to edit and manipulate the data in the spreadsheet. In this guide, we will mainly be using the **Home** and **Insert** menus to edit our spreadsheet.

2. For this section of the guide, we will use sample data from the 2A experiment, *Volumetric Analysis*.

Enter the data in columns, using one cell for each data point. Make sure all the data points from the same trial are in the same row.

In this example, we also include a header row to help keep track of the data columns, although a header row is not required for the program to create graphs or perform calculations.

As you can see in the image below, each row represents a separate trial for the experiment. Column B shows the mass of KHP used, and column C shows the volume of NaOH needed to reach the endpoint.

	A	B	C
1	<b>Trial</b>	<b>Mass KHP (g)</b>	<b>Vol NaOH (mL)</b>
2	1	0.31	16.25
3	2	0.32	15.6
4	3	0.35	16.3
5			

Figure 4. Sample data from 2A, Volumetric Analysis.

3. If we need to enter a series of **equal** intervals, such as a set of increasing wavelengths or time intervals, we can take advantage of Excel's auto-fill feature by using the **fill handle** at the bottom of an active area to quickly enter that series.

Enter the first few values from your series. Then, click on the top-most cell containing data to make it the active cell. Hold the Shift key down and click on the bottom-most cell containing data to select the rest of the data points. The green outline will expand around the entire selected area.

Hover your mouse cursor over the handle at the bottom right of the active area. The cursor will change into a small plus sign (+). Left-click and drag the handle down to another cell in the column to expand the green outline to that cell. A small hover box near the cursor also shows the value that cell will have once the series is expanded.

Let go of the mouse button to fill the selected area with the expanded series. In the following image, notice how the series can be expanded from just two initial values.

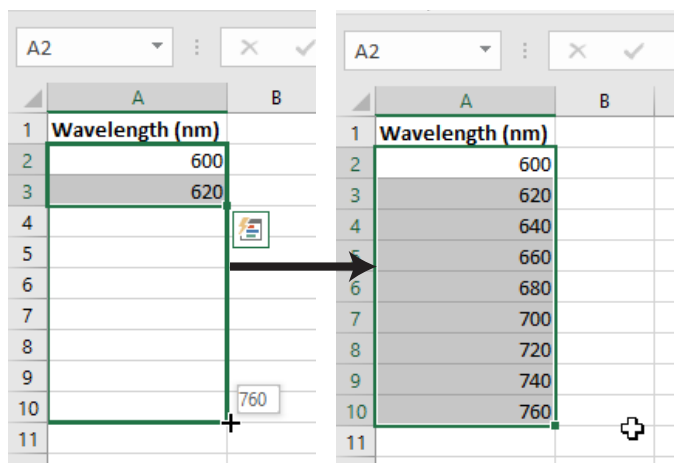

Figure 5. Using the Fill Handle to expand a series of increasing wavelengths.

The fill handle can be used across columns or rows, and can also be used to expand calculations, as you will see in the next section.

4. We may also want to change how many decimal places are displayed in each column or row, depending on what the experiment requires.

To add or remove decimal places, select an area and right click anywhere in that area. Select **Format Cells...** from the context menu to bring up the Format Cells window.

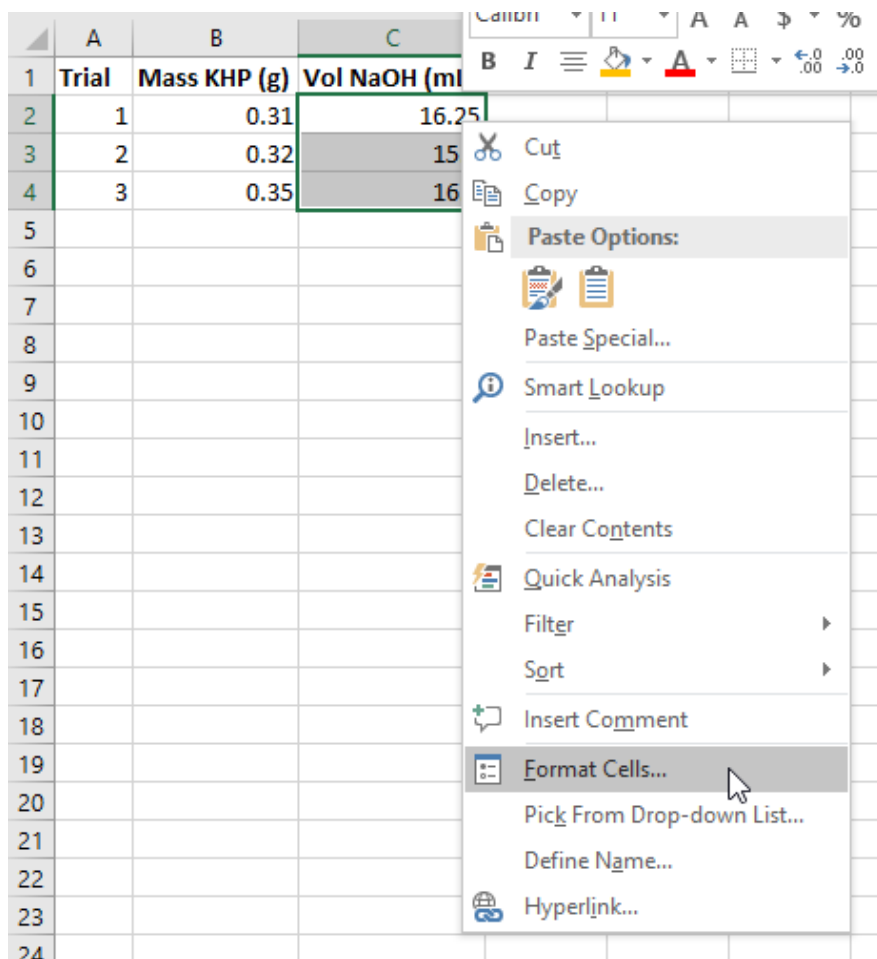

Figure 6. Select Format Cells... from the context menu.

The default category for a cell is **General**. Change the category to **Number** and set the number of decimal places as dictated by the experiment.

However, keep in mind that Excel **does not** allow you to set the number of significant figures, so you will still need to remember the rules for rounding significant figures in order to determine the number of decimal places to use.

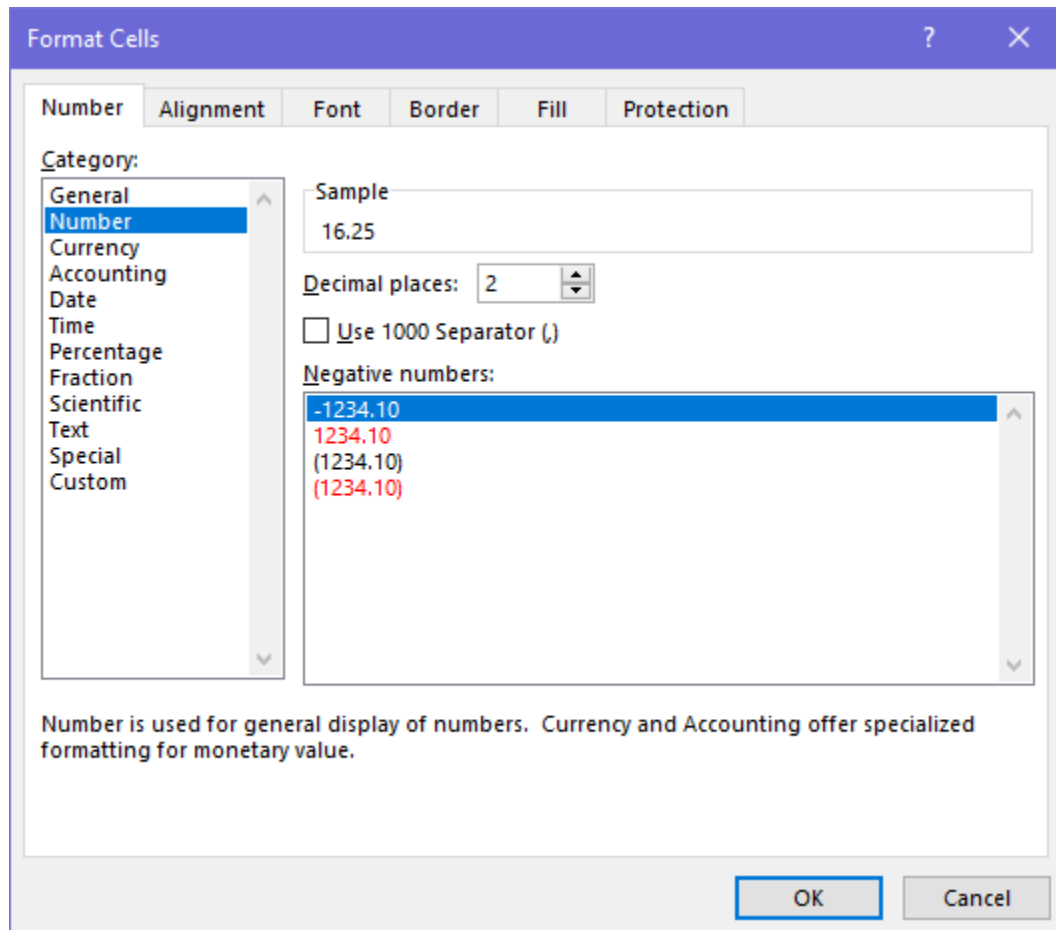

Figure 7. The Format Cells window showing the Number formatting.

## Calculations in Excel

5. Now that we've entered our raw data, we can use Excel to quickly perform calculations with that data using **formulas**.

Excel formulas always start with an equal sign (=). Formulas can use one or more *operators* or *functions*, and can contain a mix of *constants* and *cell references*. Note that Excel formulas using math operators follow the mathematical order of operations.

**Functions** are a type of procedure you can perform in Excel, denoted with an equal sign (=), a function name, such as SUM or AVERAGE, and a set of parentheses containing one or more parameters separated by commas. There are many different functions in Excel, and you can press the *fx* button next to the Formula bar to view the full list. However, in the Chem 2 course, you will most likely only need to use the mathematical functions listed below.

Common math functions for Excel	
=SUM(A1:A5)	Finds the sum of all the cells between cell A1 and cell A5.
=AVERAGE(A1:A5)	Finds the average of the values between cell A1 and cell A5.
=STDEV(A1:A5)	Finds the standard deviation of all the cells between cell A1 and cell A5.

In the *Volumetric Analysis* experiment, we perform multiple titrations of KHP with NaOH to determine the molarity of an NaOH solution. We use the following stoichiometric equation to calculate the molarity of NaOH:

$$\frac{\text{grams KHP} \times \frac{1 \text{ mol KHP}}{204.2 \text{ g KHP}} \times \frac{1 \text{ mol NaOH}}{1 \text{ mol KHP}}}{\text{volume NaOH added}} = \text{molarity (M) NaOH}$$

We can type this equation as an Excel formula using *cell references* to refer to the data we entered earlier. In this example, the mass of KHP is recorded in column B, and the volume of NaOH added is recorded in column C.

Move to the next blank column in the spreadsheet and give it an appropriate header, such as [NaOH] (M). In the row corresponding to the first trial, type out the formula using cell references to the data points from that trial. Trial 1 is recorded in *row 2*, so we refer to cells **B2** and **C2** in the formula.

Be careful to follow the order of operations and use parentheses to group operations together if needed. Excel will highlight each cell being referenced in a different color, which you can use as a visual guide to double check that you are referring to the correct cells.



	A	B	C	D	E
1	Trial	Mass KHP (g)	Vol NaOH (mL)	[NaOH] (M)	
2	1	0.310	16.25	$= (B2/204.2)/(C2/1000)$	
3	2	0.320	15.60		
4	3	0.350	16.30		
5					

Figure 8. The equation typed into cell D2 as an Excel formula.

Hit the enter key, and the formula will switch to the calculated value. You can double click on the cell to show the formula again if you wish to make any edits.

Now, we can expand that formula to apply to the other rows in the spreadsheet. Click and drag the fill handle down to the bottom-most row of data.

	A	B	C	D
1	Trial	Mass KHP (g)	Vol NaOH (mL)	[NaOH] (M)
2	1	0.310	16.25	0.093422738
3	2	0.320	15.60	
4	3	0.350	16.30	
5				

Figure 9. Click and drag the handle down to the last row of data.

Excel will automatically perform the calculation for every row in the selected area. Note how the cell references are updated for row 4 in the picture below.

	A	B	C	D
1	Trial	Mass KHP (g)	Vol NaOH (mL)	[NaOH] (M)
2	1	0.310	16.25	0.093422738
3	2	0.320	15.60	0.100454557
4	3	0.350	16.30	0.105153735
5				

Figure 10. The formula bar showing the updated cell references.

When you have a large number of trials and you need to use multiple steps in your calculation, it may be easier to do your calculations in Excel rather than on a calculator, because you only need to enter the calculation once.

6. Now, we can use functions in other cells to find the average, standard deviation, and so on. The image below shows the average for each of the 3 columns, again starting from cell B6 and using the fill handle to expand the formula across the 3 columns in row 6.

	A	B	C	D
1	<b>Trial</b>	<b>Mass KHP (g)</b>	<b>Vol NaOH (mL)</b>	<b>[NaOH] (M)</b>
2	1	0.310	16.25	0.093
3	2	0.320	15.60	0.100
4	3	0.350	16.30	0.105
5				
6	<b>Average</b>	0.327	16.050	0.100
7				

Figure 11. The formula bar shows the formula used to calculate the value in the cell.

## Graphing in Excel

7. Excel is also useful for making graphical representations of data. Graphs are an extremely valuable tool in data analysis, because they depict the relationships between data points in a format that is easy to view at a glance.

For this section of the guide, we will use the sample data found at the end of the *Strong Acid - Strong Base Titration* experiment to create a titration curve.

Enter the data in 2 columns, and click on the top leftmost cell containing data. Then, while holding down shift, click on the bottom rightmost cell containing data to select the entire field of data. Then, go to the **Insert** tab of the ribbon menu to find the graphing options.

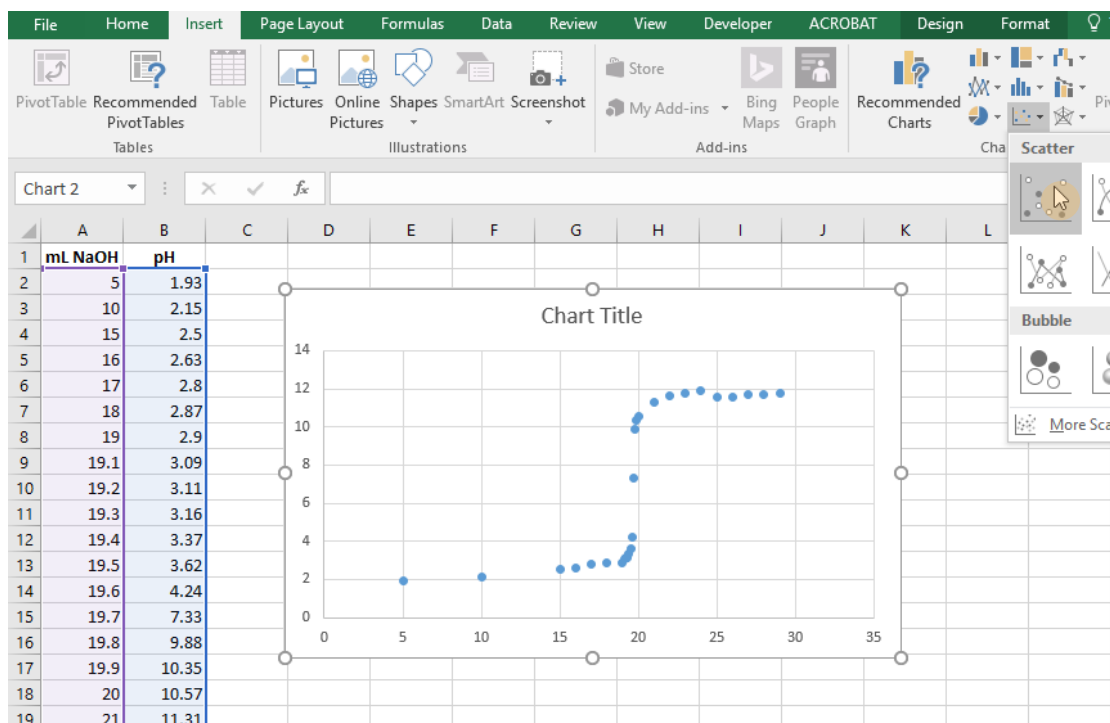

**Figure 12.** After selecting the data range, go to **Insert > Scatter** to plot the points on a graph.

There are a variety of different graph types you can create in Excel. In General Chemistry, we will most commonly use the **scatter chart** to create graphs.

With the data range selected, click on the **Insert Scatter (X, Y) Chart button** to plot the points on an xy-axis. This inserts a basic scatter graph into your spreadsheet, but we will want to edit the graph to add more information, such as axes labels or connecting lines.

8. First, let's add some lines to connect the data points and create the titration curve.

You can open up the options menu for the data points by right clicking on any one of the points and clicking on **Format Data Series** from the context menu. A menu will pop up on the right side of the screen.

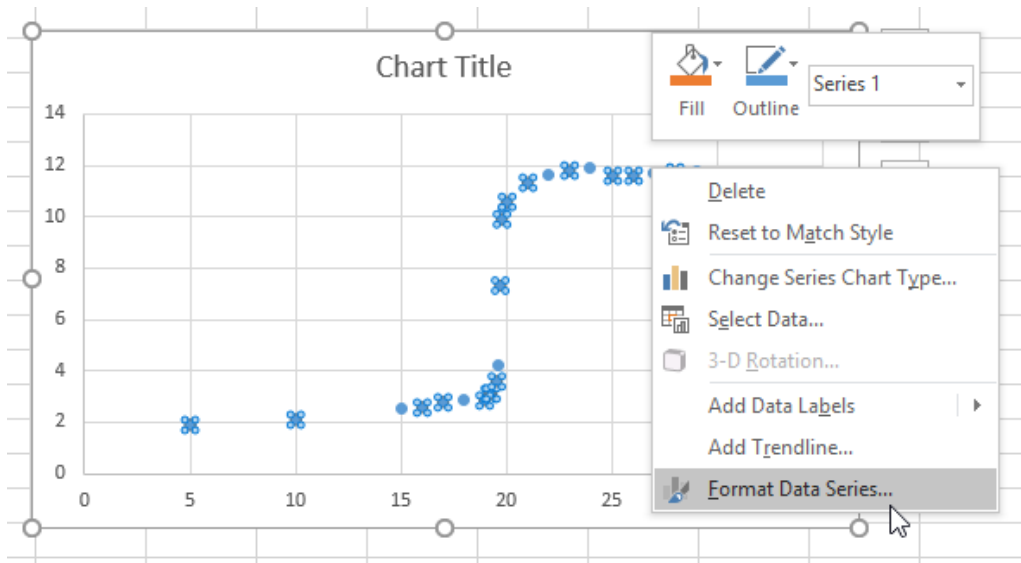

Figure 13. Select Format Data Series from the context menu to access more options.

In the Format Data Series menu, there are options to edit the Line and Marker appearances. You may have to click on the menu text to reveal all of the options.

To add lines between the points, click on the bubble next to **Solid line**.

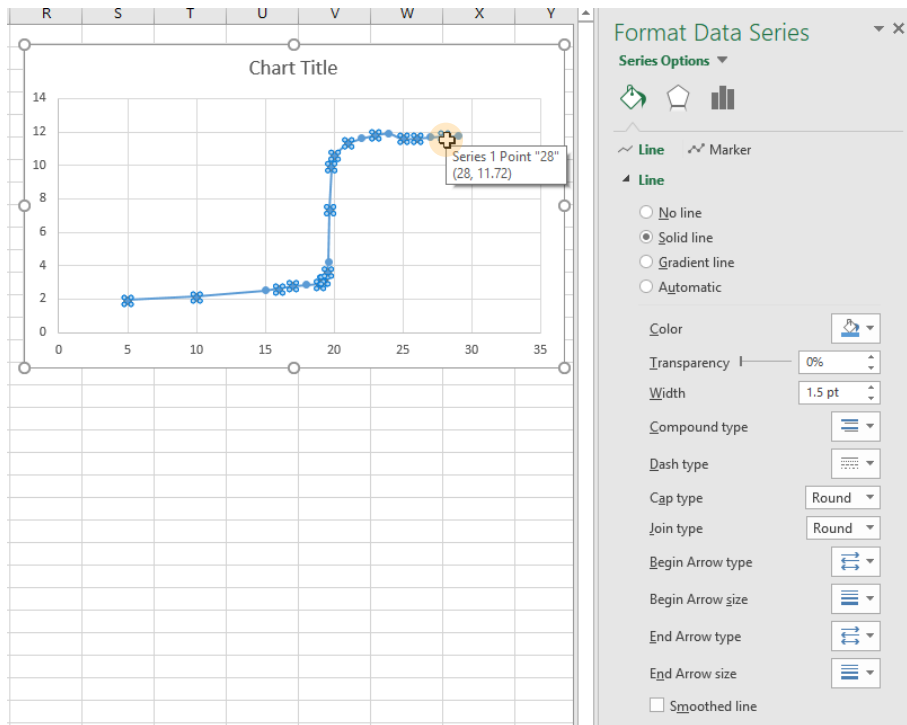

Figure 14. The titration curve with connecting lines added.

9. Next, we want to add descriptive labels to the x- and y- axes so others viewing the graph can understand what each axis represents. Select any part of the graph and click on the + button to insert chart elements. Check the box next to **Axis Titles** to insert text fields you can edit next to the x- and y- axes.

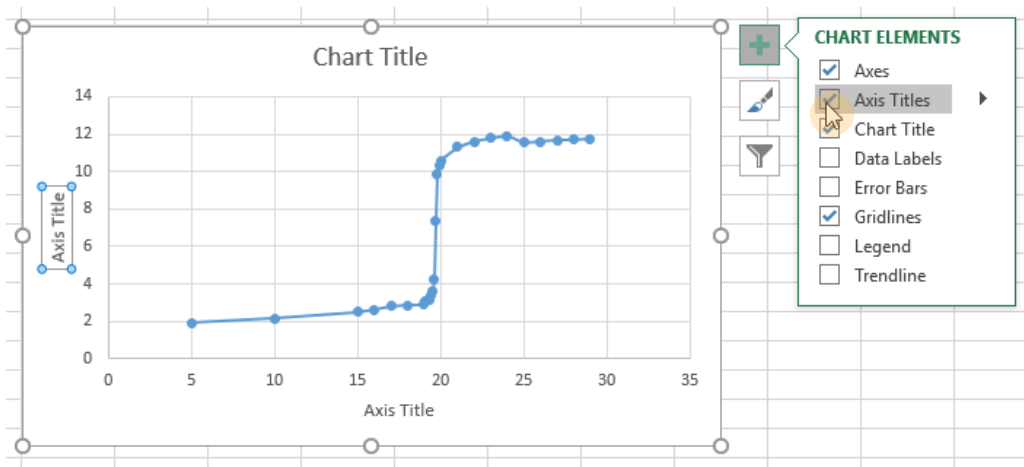

Figure 15. The Chart Elements menu.

Double click on each of the text fields to enable editing. Be sure to include your units in the axis titles, and don't forget to give your graph a descriptive title as well.

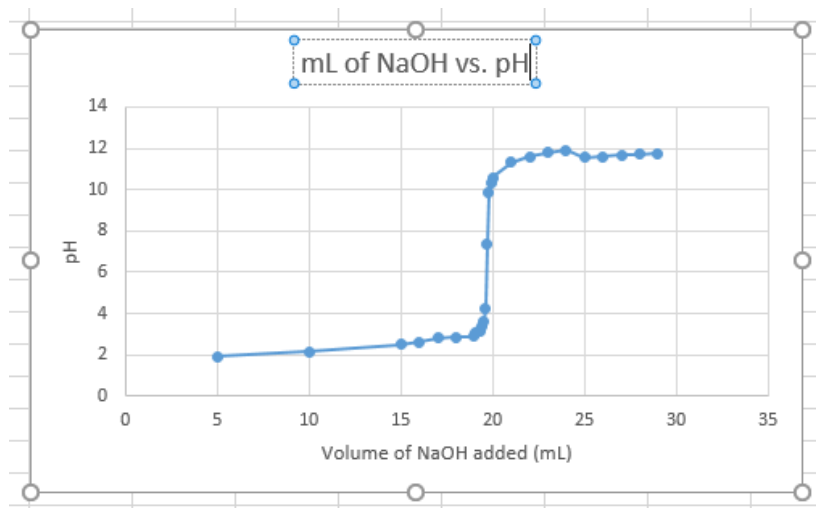

Figure 16. The titration curve with a title and axis labels added.

- Finally, we can optionally change the range of each axis to minimize the amount of empty space on the graph. Right click on either axis and click on Format Axis to bring up the **Format Axis** options menu. Here, you can change the bounds on the axis to your liking.

On this graph, there are no data points between 0 and 5, and 30 and 35 on the x-axis, so we will change the bounds to 5 and 30. The graph will automatically change to fit the new bounds.

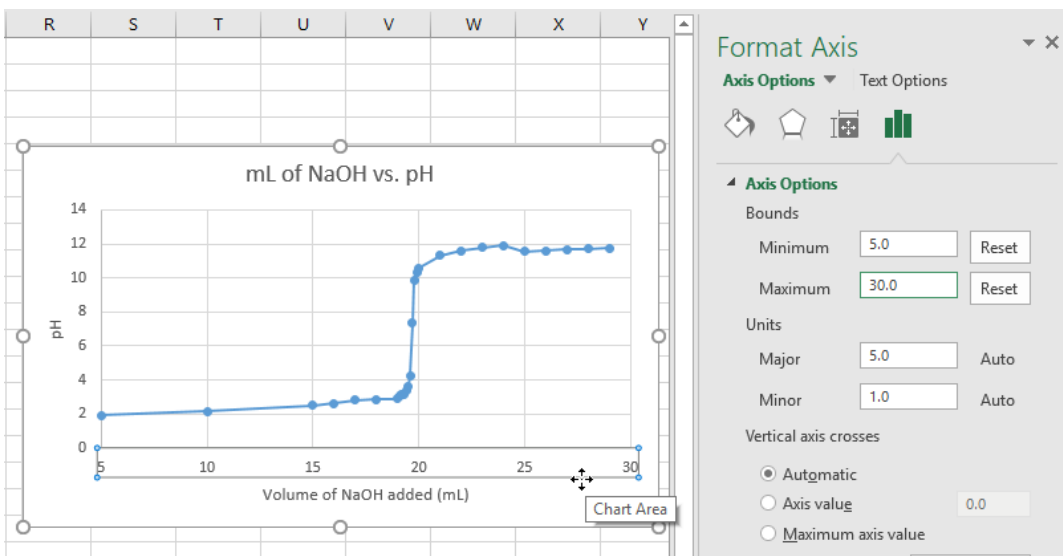

Figure 17. Changing the minimum and maximum bounds of the x-axis.

# Common Laboratory Procedures

## Handling Solids

### 1. General Guidelines for Handling Solids

1. Use a **clean** spatula or scoopula to transfer solid from bottles. Never use a contaminated spatula.
2. Never return unused solid to the reagent bottle. To eliminate waste, avoid removing more solid from a bottle than is necessary.
3. Never discard chemicals in the trashcan. Follow waste disposal procedures outlined in the Laboratory Manual.

### 2. Quantitative Transfer

Quantitative transfer refers to the moving of *all the contents* to be transferred from one container to another. Below is an illustration of how to properly weigh and transfer a solid using weighing paper. You will be using weighing boats rather than weighing paper, but the procedure is essentially the same.

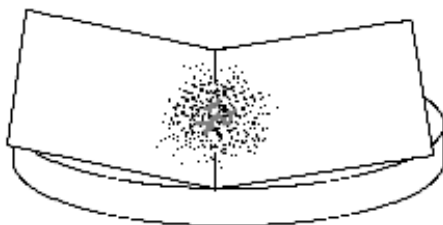

Fold a weighing paper in half and tare it. Weigh out the solid and record the mass.

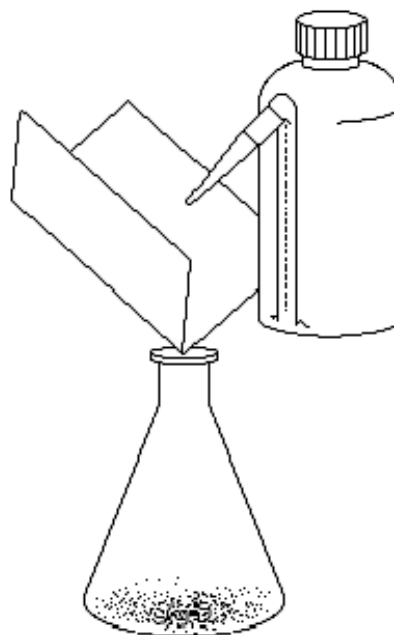

Pour the solid into the flask. Using a water bottle, wash the remaining solid on the paper into the flask.

Figure 1. Quantitative Transfer of Solids

### 3. Using the Desiccator

You will occasionally be asked to use the desiccator during the laboratory course to dry some reagents. The desiccator contains some amount of desiccant, which absorbs moisture from air.



1. **Keep the desiccator closed at all times.**

The desiccant will absorb moisture in the air extremely rapidly.

2. **Keep the desiccator tightly sealed with some vacuum grease.**

To apply vacuum grease, put a pea-sized amount of grease on a paper towel and wipe it along the rim of the transparent cover. Make sure you do not use too much grease. Place the cover on top of the base and twist the cover 30 degrees to ensure a tight seal.

#### Desiccator Care

In the Chemistry 2 lab, we use Calcium Chloride as the desiccant. If water is found in the desiccator, discard the desiccant in the sink and rinse with copious amount of water until all solids are dissolved. Wipe the desiccator dry with a paper towel. Make sure all traces of water are removed before refilling from the 10 kg bucket of Calcium Chloride in your lab.

#### Hard to Open Desiccator

Do not try to force open a desiccator. You may accidentally shatter the glassware stored inside. Use an aluminum scoopula as a wedge and push it slowly into the space between the covers.

#### Notice

- Always keep the desiccator upright and closed in your locker.
- Clean up Calcium Chloride spill immediately. Moisture will damage drawers.



# Handling Liquids

## 1. Drawing Solutions from a Reagent Bottle

Most reagent bottles in your laboratory have a small test tube holder attached for a disposable (dispo) plastic pipette. To avoid cross-contamination, always use the assigned dispo pipette to draw solutions from the reagent bottle. Do not use your glass pipet with reagent bottles.

### Caution

- Improper use of disposable pipets may cause serious injuries!
- Never point the pipet at yourself or others!
- Do not squeeze air into solutions with the dispo pipet. This may result in chemical splashes.
- Always put full dispo pipet in a test tube when carrying it to another part of the lab.

## 2. Estimating Volume with a Dispo Pipet

The dispo pipette may be used to transfer an estimated amount of solution. This is useful when working with non-limiting reagents or quickly making a solution that will be titrated later.

To draw 1 mL of solution into an empty dispo pipet:

1. Squeeze the bulb to remove some air from the dispo pipet.
2. Submerge the tip of the dispo pipet in the solution.
3. Slowly release the pressure on the bulb and draw solution to the 1 mL mark.
4. Without releasing pressure on the bulb, steadily remove the dispo pipet from the solution.

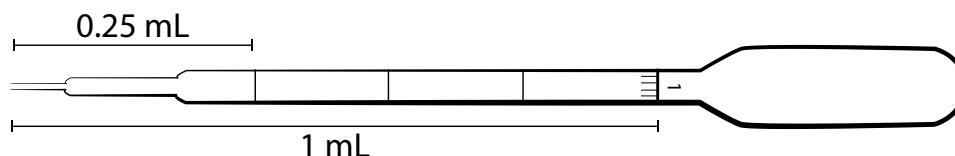

### 3. Transferring Liquid

1. When transferring liquids from a reagent bottle, always remove the cap/stopper and hold it in your hand. Never place the cap/stopper on the bench or contamination could result. Pour the liquid slowly and carefully to avoid spillage. You may find the use of a glass rod helpful, as shown below.

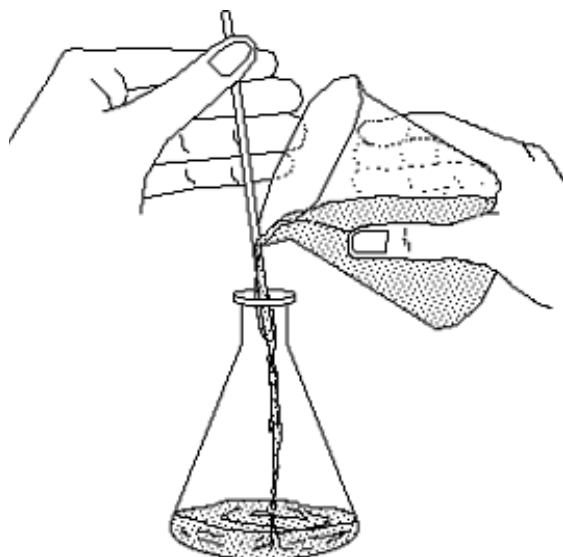

Figure 2. Liquid Transfer with Glass Stir Rod

2. With the exception of beakers, you should always use a funnel when transferring liquids from a container with a large opening to a container with a small opening.

### 4. Capping a Flask with Parafilm

During many experiments you will have to cap a flask to protect the contents from contamination. **Figure 3.** illustrates the proper method using Parafilm.

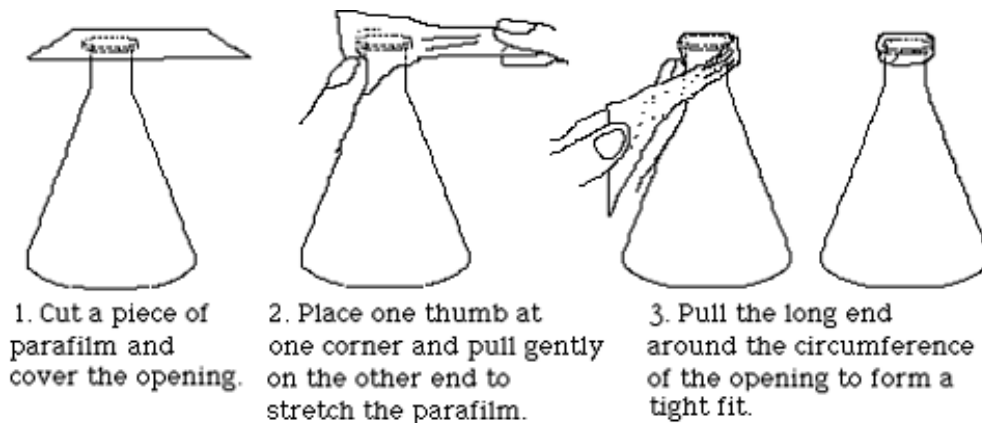

Figure 3. Capping A Flask

## 5. Measuring Liquid Volumes

Many glassware items have volume marks printed on them. Before using a piece of glassware to make a volume measurement, you should take a moment to study its calibrations to insure that you know how to read them properly.

- A beaker or Erlenmeyer flask can be used for rather rough measurements.
- A graduated cylinder can be used for measurements of moderate accuracy.
- A pipet is commonly used to transfer an accurately known volume of a liquid.

However, the accuracy of such a transfer is only as good as the technique of the operator will allow.

In making any volume measurement, the liquid level should always be the same as your eye level. Erlenmeyer flasks and graduated cylinders are usually filled/read by *raising them to your eye level* rather than by squatting down to bring your eye level to the bench top. The liquid level in a pipet is always lowered to the mark while the mark is held steady at eye level.

**Burets:** With practice, the position of the meniscus of a liquid in the 25 mL burets used in the Chemistry 2 labs can be estimated to within 0.02 mL.

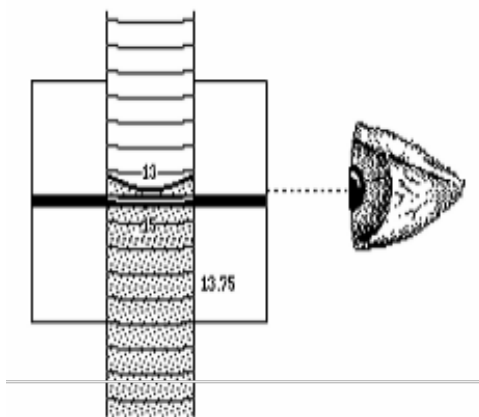

Figure 4. Reading the Meniscus

**Figure 4.** shows the use of a card with a dark strip on it to sharpen the image of the meniscus. You will find by experiment that if the top of the strip is positioned slightly below the level of the liquid in the buret, the bottom of the meniscus will be very easy to see.

## Common Glassware in the Laboratory

Almost all of the glassware used in the Chemistry 2 laboratories are made with borosilicate glass, which is able to resist high temperatures and most chemicals.

### 1. Care and Maintenance of Laboratory Glassware

1. Always examine the glassware for chips and scratches before use. Damaged glassware may break during normal usage or cause bodily injuries.
2. Never place glassware near the edge of lab bench. Keep the work area clean and organized to prevent accidents and chemical spills.
3. Clean broken glassware must be disposed of inside the designated **Glass Disposal Box**. If box is full, ask the dispensary for a new one.
4. Clean all glassware with water. Make sure to rinse the glassware with DI water as a final step.
5. Never heat glassware to dryness. Add cold water with your **250 mL water squeeze bottle** when needed.
6. Never place a heated beaker in an ice bath, or vice versa. Allow the glassware to warm up or cool down gradually.
7. Never carry lab ware by the neck or cap. Always hold lab ware from the bottom and the side.
8. Never use tape or sticky labels on laboratory glassware. Always write on the white or blue label area with graphite pencil (a.k.a. “lead pencil”).

## 2. Beakers

Beakers can be used in the laboratory to estimate volume, storing liquids temporarily, and carry out certain reactions.

1. Always hold beakers from the bottom or the side. Never hold a beaker by the rim.
2. All beakers in the Chemistry 2 laboratories have a pouring lip to make pouring solutions easier.
3. All beakers in the Chemistry 2 laboratories have marks for estimating the volume. As noted on the glassware, there is a  $\pm 5\%$  error for the largest volume mark.
4. Place a 100 mm watch glass on top of beaker when boiling water to speed up the process.
5. If needed, write labels in the frosted areas on the beaker with graphite pencils (a.k.a. "lead" pencils). **Do not use wax pencil or pen!**

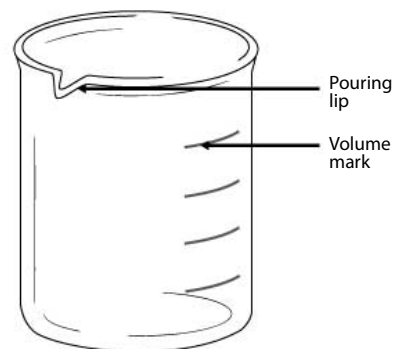

## 3. Erlenmeyer Flasks

Erlenmeyer flasks can be used in the laboratory to estimate volume, storing liquids temporarily, and carry out certain reactions.

1. All Erlenmeyer flasks in the Chemistry 2 laboratories have marks for estimating the volume. As noted on the glassware, there is a  $\pm 5\%$  error for the largest volume mark.
2. If needed, write labels in the frosted areas on the beaker with graphite pencils (a.k.a. "lead" pencils). **Do not use wax pencil or pen!**

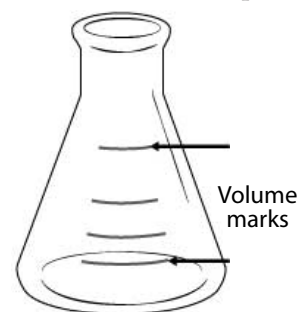

## 4. Graduated Cylinder

Graduated cylinders are used to measure a small volume of liquid with more precision than beakers and Erlenmeyer flasks.

1. The graduated cylinders in the Chemistry 2 laboratories include a plastic base and a plastic ring. The plastic ring is to protect the glass cylinder from shattering when the glassware is knocked over. Make sure the plastic ring is placed near the top of the cylinder.
2. To quickly measure out a specific amount of water, fill your **250 mL water squeeze bottle** with DI water and squeeze the desired amount of water into the graduated cylinder.

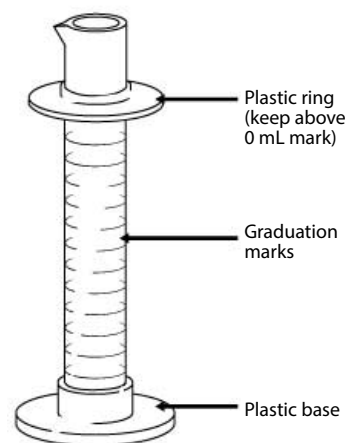

### 5. Volumetric Flasks

Volumetric flasks are very precisely calibrated glassware designed to contain one specific volume of liquid. You will only be allowed to have a limited number of volumetric flasks. If you need to make multiple solutions accurately with a volumetric flask, do not use multiple volumetric flasks. Instead, pour solutions you made in another container and reuse the same volumetric flask.

1. The 250 mL volumetric flask used in the Chemistry 2 laboratories has only one graduation mark for volume of 250 mL. As noted on the glassware, there is a  $\pm 0.12$  mL error at 20 °C.
2. To fill a volumetric flask to the mark, quickly fill the flask to where the round base meets the neck. Cap the bottle and swirl or invert if needed. Then use a **250 mL water squeeze bottle** to fill to the volume mark. Notice that the volume between the neck and the 250 mL volume mark is only 10 mL.
3. Never use glass pipets or dispo pipets to draw solutions from volumetric flasks. Pipets will become stuck inside the flasks.

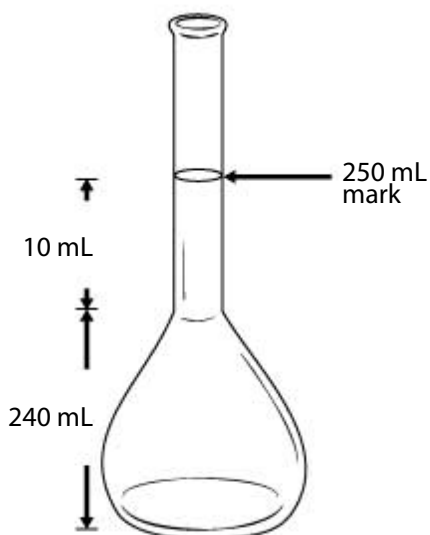

## 6. Burets

Burets are used to deliver a precise amount of solution. Unlike the volumetric flask and graduated cylinder, which are calibrated to measure the liquid contained in the glassware, burets are calibrated to measure the liquid delivered from the glassware. In the Chemistry 2 labs, the buret is mostly used for titrations.

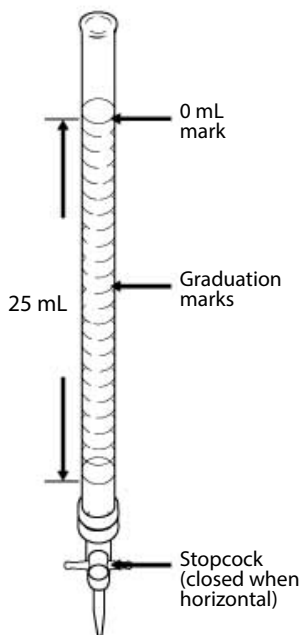

### 1. Filling the buret with DI water:

- Always remove the buret and hold it below your eye level when filling the buret.
- Check to make sure the stopcock is in the closed position.
- Always use a funnel and a small beaker (100 mL or 150 mL). For a 25 mL buret, pour 30-40 mL of DI water into the beaker.
- Hold the buret slightly below the 0mL mark with one hand; slowly pour into the buret the solution from the beaker in your other hand. Stop before the liquid level reaches 0 mL.

### 2. Cleaning the buret:

- To clean a buret, fill it to half way with DI water.
- At the sink, open the stopcock and drain out ~10 mL of water and close it. Then invert the buret and open the stopcock and drain out the rest from the top.

### 3. Conditioning the buret:

You should always condition your buret with your working solution before using it.

- Clean the buret with DI water.
- Fill the buret with 8-10 mL of the solution to be used. Open the stopcock to drain out a small amount from the tip into an appropriate waste container.
- Cap the top end with Parafilm. At the sink, hold the top of the buret between the thumb and finger of one hand, and hold the tip of the buret with another. Turn the buret horizontal and rotate the tip of the buret. Make sure all sides of the buret are washed with the solution.
- Pour the remaining solution in the buret into an appropriate waste container.

### 4. Dispensing solution from the buret:

- First, fill the buret with your solution to near the 0mL mark, but do not attempt to fill it to exactly 0.00 mL. Open the stopcock and drain out a very small amount to ensure no air bubbles exist in the tip. Record in your lab notebook your buret initial reading.
- Open the stopcock and drain the solution. Stop when the target volume is reached. Record the buret final reading in your lab notebook. The difference between the **initial reading** and the **final reading** is the volume dispensed.
- To dispense in small quantities, quickly turn the stopcock clockwise exactly 180 degrees. Repeat as needed.

### 7. Volumetric Pipet

Similar to the buret, the volumetric pipet is designed to deliver a precise amount of solution.

1. The volume of liquid each pipet is designed to deliver is labeled on the glassware. Use the volumetric pipet *only* when you need to deliver the exact amount of solution with precision.
2. There is a bottle of volumetric pipet cleaning solution in each laboratory. Draw the cleaning solution into the pipet with a pipet bulb and dispel the solution
3. To condition a volumetric pipet, draw a small amount of your working solution into the pipet just above the volume mark. Drain the solution into an appropriate waste container.
4. Follow the illustration below to learn how to use the volumetric pipet. You should practice using deionized water first to become proficient with the techniques.

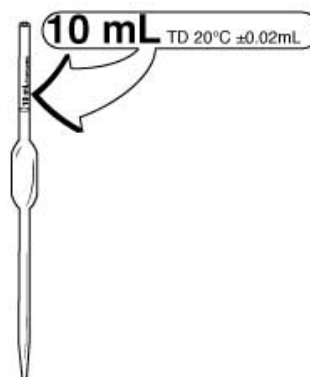

#### Caution

- Never mouth pipet. Always use the pipet bulb with tip attached.
- Never point your pipet or pipet bulb at yourself or others.
- Never squeeze air into solutions as it may cause chemical splash.
- Never draw solutions into the bulb. Corrosive solutions will dissolve the rubber and contaminate the pipet.



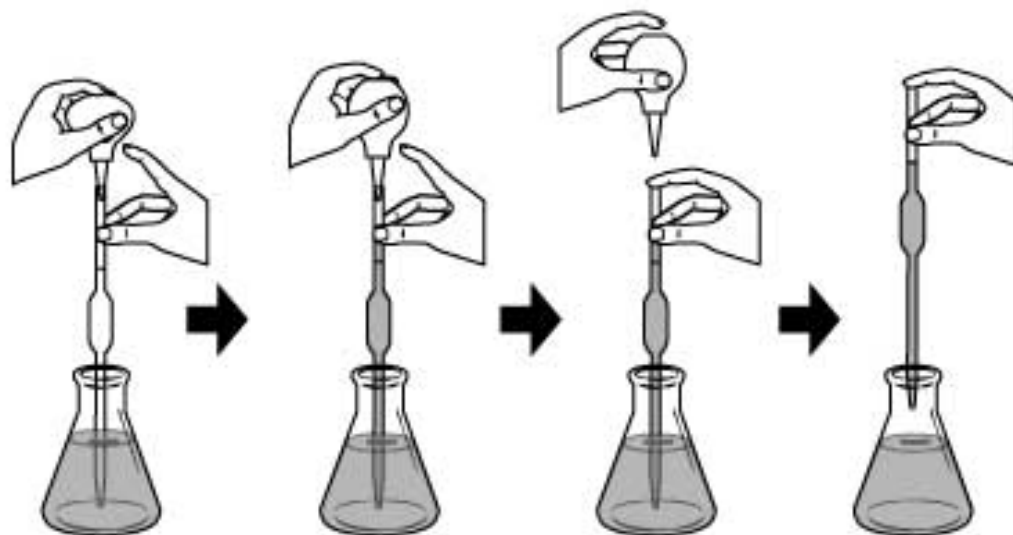

1. To begin:
  - With one hand, hold the conditioned pipet vertical and the pointed end downward inside the container of your working solution. Place your other hand near the top of the pipet and keep the index finger free so that it can easily cap the pipet.
  - With your other hand, deflate the rubber pipet bulb with tip with your thumb.
  - Place the plastic pipet tip on the top of the pipet.
2. To draw the solution:
  - Slowly release your thumb and draw the liquid up the pipet and a few centimeters above the mark on the pipet. Keep the pipet submerged in solution to avoid drawing up air.
  - Lower the pipet so that it reaches the bottom of the container. Quickly remove the **pipet bulb with tip** and cap the pipet with your index finger.
3. To adjust the volume:
  - Raise the over-filled pipet. Raise the mark on the pipet to your eye level, tilt the receiver slightly, and touch the pointed tip of the pipet to a dry spot on its sidewall.
  - Rotate the pipet left and right slightly and let a small amount of air to enter the pipet and thereby allow the meniscus to fall exactly on the volume mark. Be patient, because if you overshoot the mark you must begin the whole process again.
4. To deliver the liquid:
  - Remove the accurately filled pipet from its container. Quickly dry the lower portion of the shaft with a single downward stroke of a laboratory tissue.
  - Tilt the final receiver slightly and while holding the pipet vertical, place its tip against the receiver wall so that when you take your finger off of the pipet mouth, liquid will flow smoothly down to the bottom of the vessel. Avoid splashing.
  - Do not squeeze solution out with the **pipet bulb with tip** and do not blow out the last drop. **The pipet is calibrated to deliver with one last drop left in the pipet.**

## Using the Balance

A balance is used to measure the mass of an object. There are 4 analytic balances assigned to your laboratory section for use in the adjoining balance room. These balances measure the mass to the nearest milligram. You will use these balances for most mass measurements in the Chemistry 2 lab experiments.

There is also a less precise “quick” balance in your lab room, between the fume hoods. You may use this balance to make rough measurements of non-limiting reagents quickly and speed up your experiment without compromising the experiment results.

### 1. On/Off Switching

1. To turn on the balance, remove all load from the weighing pan and press the **On** button.
2. To turn off the balance, press and hold the **Off** key for 2 seconds.

### 2. Simple Weighing

Open one of the draft shield sliding doors. Make sure the balance pan and surrounding area is clean. You can clean it with a balance brush or Kimwipe.

Next, shut the doors and press the **O/T button** to set the balance at zero.

Now, simply place the object to be weighed on the weighing pan and measure the mass to 0.001 grams.

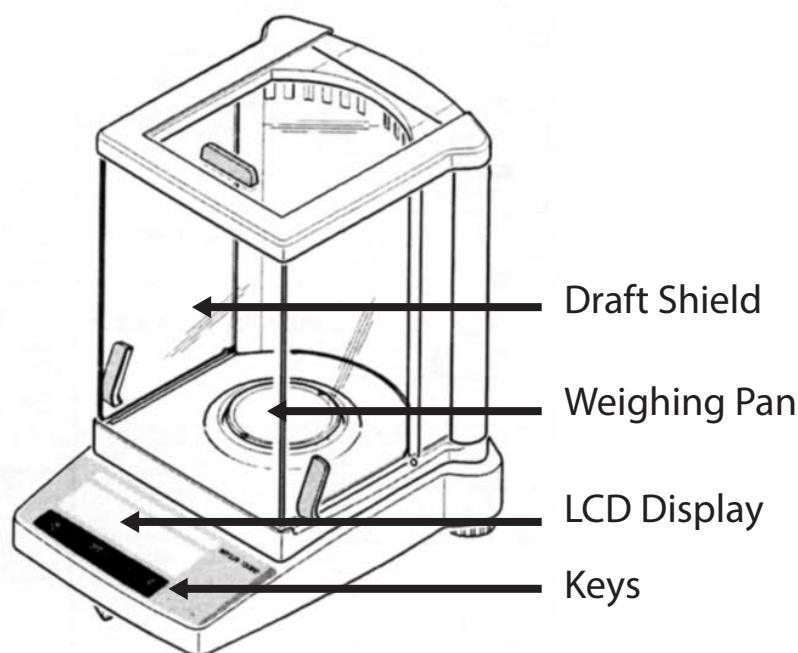

Figure 5. The Analytical Balance

**Notice**

- Always use weighing boats when weighing solids to protect the balance. To do this, place the plastic weighing boat on the balance pan and be sure it is not touching the sides.
- Always use the balance with extreme care, as it is very expensive.

**3. Taring**

To measure the mass of sample inside a container, perform the following procedures:

1. Place the empty container (e.g. a weighing boat) on the balance.
2. Press the **0/T** key briefly. The display should read 0.000 g.
3. Add the sample to the container. Read the displayed mass to 0.0001 g.

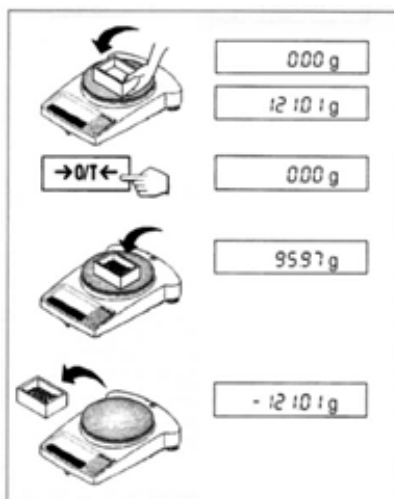

Figure 6. Taring

**4. Weighing by Difference**

To measure the mass of a sample by difference:

1. Clear the weighing pan. Press **0/T**. The reading should be 0.000 g.
2. Place the container with the sample on the balance. Record the mass.
3. Remove a portion of the sample from the container.
4. The difference between the two readings is the mass of the removed portion of the sample.

## Using the Centrifuge

A centrifuge machine is used to separate the different constituents of a solution by their density. In many experiments, you will be required to separate precipitation products from solution using the centrifuge machine.

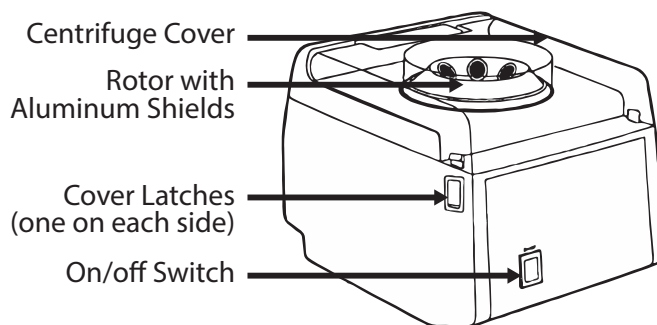

Figure 7. The Centrifuge

### 1. Procedure

1. Always load centrifuge tubes of about equal weight. Fill another centrifuge tube with water to equal weight to balance.
2. To balance the tubes, place a small beaker on the “quick” balance in your lab room. Weigh your sample tube. Fill another centrifuge tube with water to equal weight (to the nearest 1g).
3. Place the centrifuge tubes in the aluminum shields on opposite sides. The centrifuge tubes should fit inside the aluminum shield snugly. Use a different tube if more than 1/8 inch of the glass is exposed.
4. Close the cover. Lock both sides securely into the latches.
5. Press the On/Off switch to turn on the unit. Press the switch again to turn it off.

#### Warning

- Improper use of the centrifuge machine may result in serious injury. Follow all safety precautions when operating the centrifuge machine.

### 2. Safety Precautions

1. Operate the centrifuge only when the cover is securely closed.
2. Never open the cover when the centrifuge is running.
3. Always balance the tubes before loading. Only spin 2, 4, or 6 tubes.
4. **Never spin 1, 3, or 5 tubes.**
5. Turn off the machine immediately if there are signs that the load is unbalanced.
6. Never open the cover before the rotor comes to a **complete** stop.
7. Never stop the rotor with your hand. Serious injury may result.

## Using the Hot Plate

The hot plate is used to heat solutions in nearly all experiments performed in the Chemistry 2 laboratory. However, improper use of the hot plate may result in serious injury. Follow all instructions and exercise caution when using the hot plate.

There are a variety of hot plates used in the Chemistry 2 labs, but they all have the same essential features.

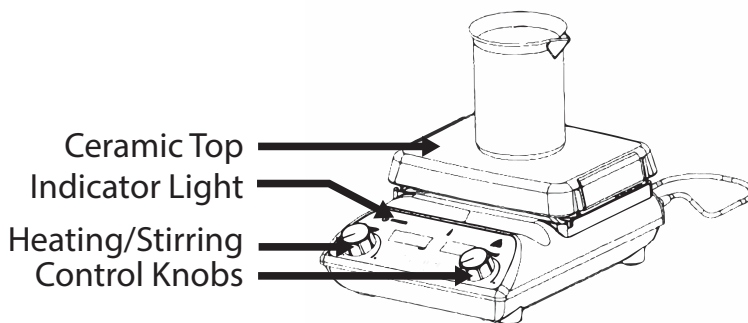

Figure 8. The Hot Plate/Stirrer

### 1. Features

1. **The Ceramic Top:** The heating surface. The temperature may reach a maximum of over 400 °C. Do not touch the ceramic top. It may cause serious burns. The ceramic top is also very delicate. Clean up spills immediately and avoid hitting the surface with heavy objects.
2. There are four common indicating lights on all models used in the Chemistry 2 laboratories. They are: the Power Indicator, the Heat Indicator, the Stir Indicator, and the Hot Top indicator.
  - **Power Indicator:** On if the unit is plugged in to a power source. Check power cord connection if not on.
  - **Heat Indicator:** On if the heat is turned on.
  - **Stir Indicator:** On if the magnetic stirrer is turned on.
  - **Hot Top Indicator:** On if the top has a temperature of over 60°C. Do not unplug the unit if the top plate is still hot.

#### Warning

- The hot plate may cause serious burns. Avoid touching the top plate and follow all safety precautions.

### 2. Safety Precautions

1. Keep the power cord away from the heating surface. The cord may melt and cause an electrical hazard.
2. Do not hit the top with heavy objects. It may break if impacted.
3. Do not heat volatile or flammable materials.
4. Do not operate near volatile or flammable materials.

The hot plate must not be used during these experiments:

- **2A.** Determination of Avogadro's Number
- **2B.** Colligative Properties

5. Avoid spilling liquids on the ceramic top. Do not over boil solutions.

It takes approximately 15 minutes to boil 400 mL of water at Heat setting 6. Avoid turning the heat setting too high. Spills from over-boiling will damage the hot plate and may result in personal injury.

6. Never use a container larger than the top plate.
7. Never boil a solution to dryness.

## Heating with a Bunsen Burner

In using a Bunsen burner, always use a tight blue flame as shown in the illustration below. Always estimate the appropriate height for the iron support ring before turning on the Bunsen burner. Control the heat transfer by adjusting the distance from the burner to the object. Note that the distances suggested in the manual are measured from the hottest part of the flame to the object.

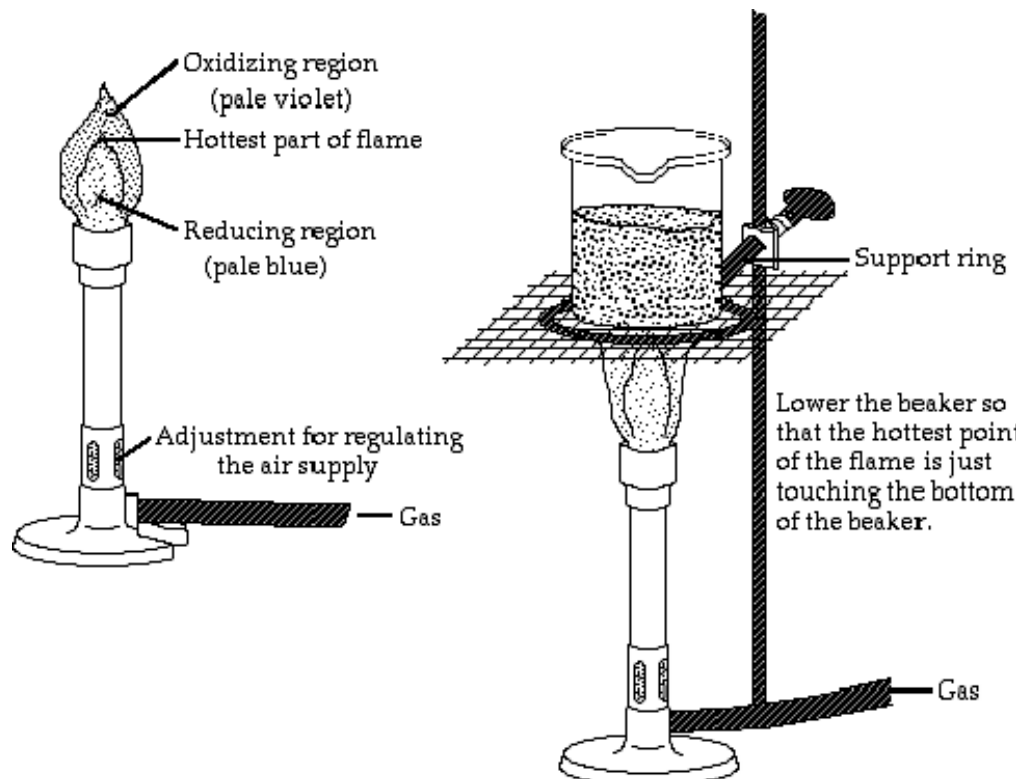

Figure 9. The Bunsen Burner

### Warning

- Only use the Bunsen burner when specifically instructed by the lab manual.
- Keep all flammable materials away from the Bunsen burner.
- Heated lab ware including iron rings can be extremely hot and may cause serious burns!

## Filtration

You will often need to separate a liquid from a solid. At times you will simply decant, that is, you will carefully pour out the liquid, leaving the solid behind. At other times you will need to filter the solution. To do this you will use filter paper and a funnel. You must first fold the paper in order to accelerate the process; this is shown in Figure 7.

You will then set the paper in the funnel using your wash bottle. To do this simply place the paper into the funnel and add a small amount of water to the bottom of the filter.

Slowly add water to the sides with a circular motion to avoid air bubbles between the paper and the funnel. Once the paper has set, transfer the solution to be filtered. If the solid has settled, decant the liquid through the filter first in order to save time.

Never overwhelm the filter; don't add the solution too quickly and never come to within one centimeter of the top of the paper. Transfer the solid using a wash bottle and rubber policeman, and then wash the solid as directed by the experimental procedure.

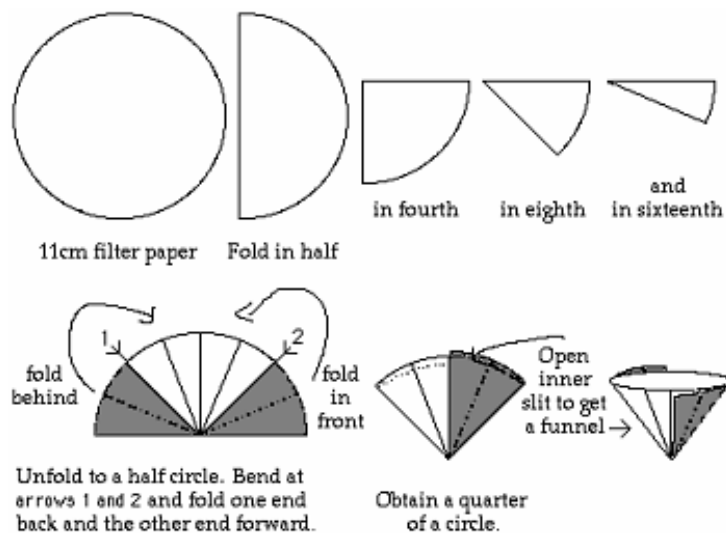



# pH Meter Operating Instructions



## 1. Preparing the pH meter

1. Turn on the pH meter.
2. Meter must be in pH mode. If in mV mode, press the **pH/mV** button.
3. Make sure pH meter is showing  $\bar{\Delta}$ . If not shown, press and hold **Read** button for 2 seconds.
4. Lower left window must show **B1 7.00 4.00 10.01 1.68**. If not, ask your TA to adjust the setting.
5. You may adjust the electrode stand to secure the electrode. Loosen the tension knob to adjust arm position and tighten the tension knob before use.

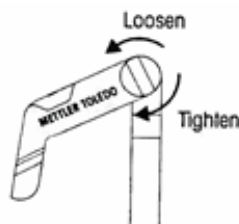
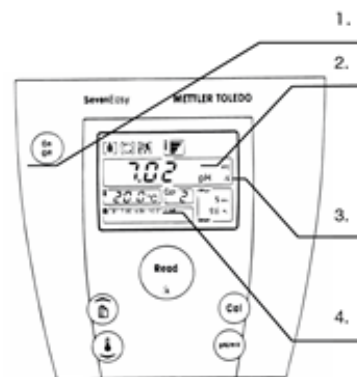

**Caution:** Do **NOT** place test tubes on electrode stand!

6. Do NOT let electrode dry out. **Always store electrode in saturated KCl solution when not in use.**

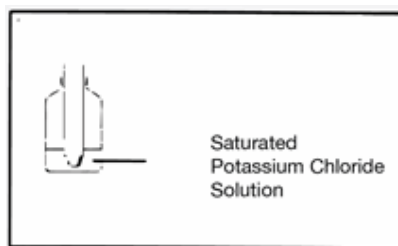

## 2. Calibrating the pH meter

**Note:** You only need to calibrate the pH meter **once** per lab period.

1. Rinse the electrode with DI water.
2. Blot dry with Kimwipe.

**WARNING:** Do **NOT** rub the electrode with Kimwipe. Rubbing the electrode may build up static charge and damage the electrode.

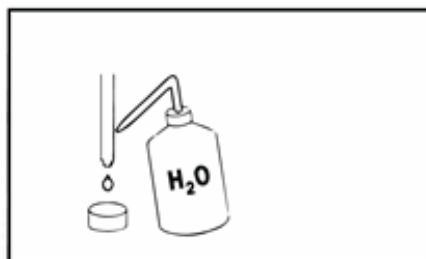

3. Place electrode in pH 7 buffer standard (yellow).
4. Press the **Cal** button.
5. Wait for the display to stop blinking.

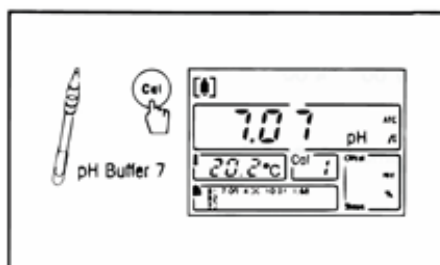

6. Repeat step B-1 to B-5 with the pH 4 buffer standard (red) and then with the pH 10 buffer standard (blue).

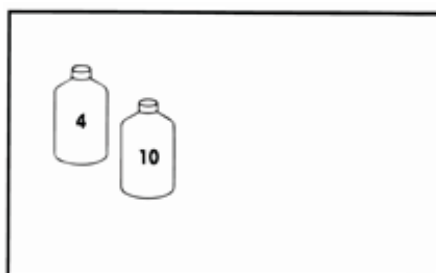

### 3. Measure the pH of sample

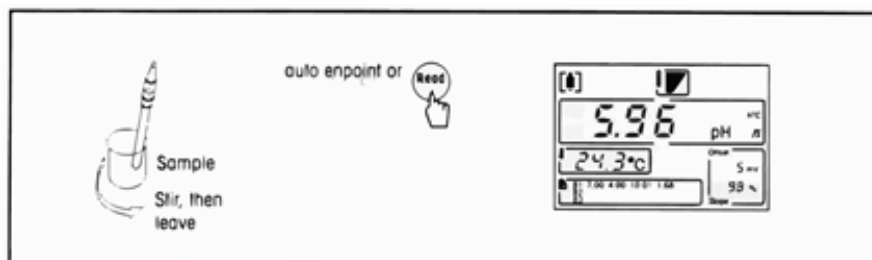

1. After calibration, place the electrode in sample solution and press **Read**.
2. Wait for the reading to stabilize.

## Fume Hood Use and Safety

The fume hoods in the laboratory protect personnel from hazardous materials and inhalation of toxic materials.

### 1. Features of the Fume Hood

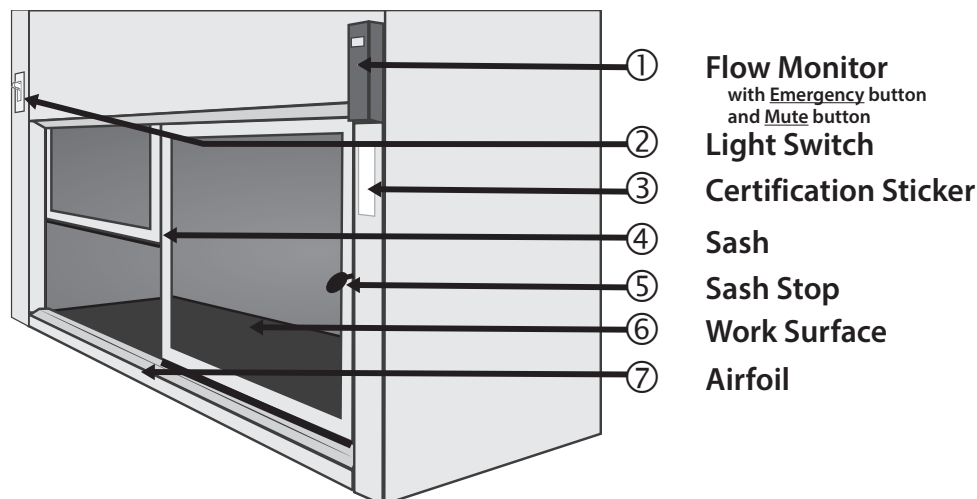

### 2. Before using the fume hood

1. Check the **certification sticker** (③). The Fume Hood is tested and certified every year.
2. Check the flow monitor (①).

Laboratory fume hood should have 100 ft/min face velocity or more. Lower the sash if to increase airflow. If airflow does not reach 100 ft/min, stop work in the fume hood and contact safety personnel immediately.

3. Turn on light switch (②).

### 3. Guidelines for working with the fume hood

1. Lift the sash up slowly about 12 inches. Never raise the sash above the sash stop (⑤).
2. Always place lab equipment at least six inches away from the edge and inside the fume hood as much as possible.
3. Do not rest body parts on the edge or the Airfoil (⑦).
4. Do not place glassware or chemicals on the Airfoil (⑦).
5. Move unused equipment and chemicals away. Remove your glassware when done.

Remember, you are sharing the fume hood with 23 other students. Remove your glassware as soon as possible and clean your glassware. Do **NOT** abandon your lab ware in the fume hood!

6. When increased airflow is needed, press the **Emergency** button and the **Mute** button.
7. **Clean up spills immediately.**
8. **Cap all containers immediately.**
9. Turn off **Emergency** mode and close hood sash all the way at the end of lab.

#### **4. Using the fume hoods in the Chemistry 2 Laboratories**

1. **Always use the fume hood when directed by the Laboratory Manual.**

Certain reactions in the Chemistry 2 curriculum generate toxic or flammable gases. Follow instructions to protect yourself and others in the lab.

2. Many hazardous chemicals are kept in the fume hood. Never remove these containers unless specifically directed by the Laboratory Manual.
3. All Hazardous Waste containers for the Chemistry 2 course are kept in the fume hood.

#### **5. Fume Hood Emissions**

1. Minimize fume hood emissions to protect the environment and air quality.
2. Never evaporate waste in the fume hood.
3. Minimize use of volatile liquids. Close and seal after using.

**If you have questions, contact your TA or safety coordinator.**

# Locker Inventory

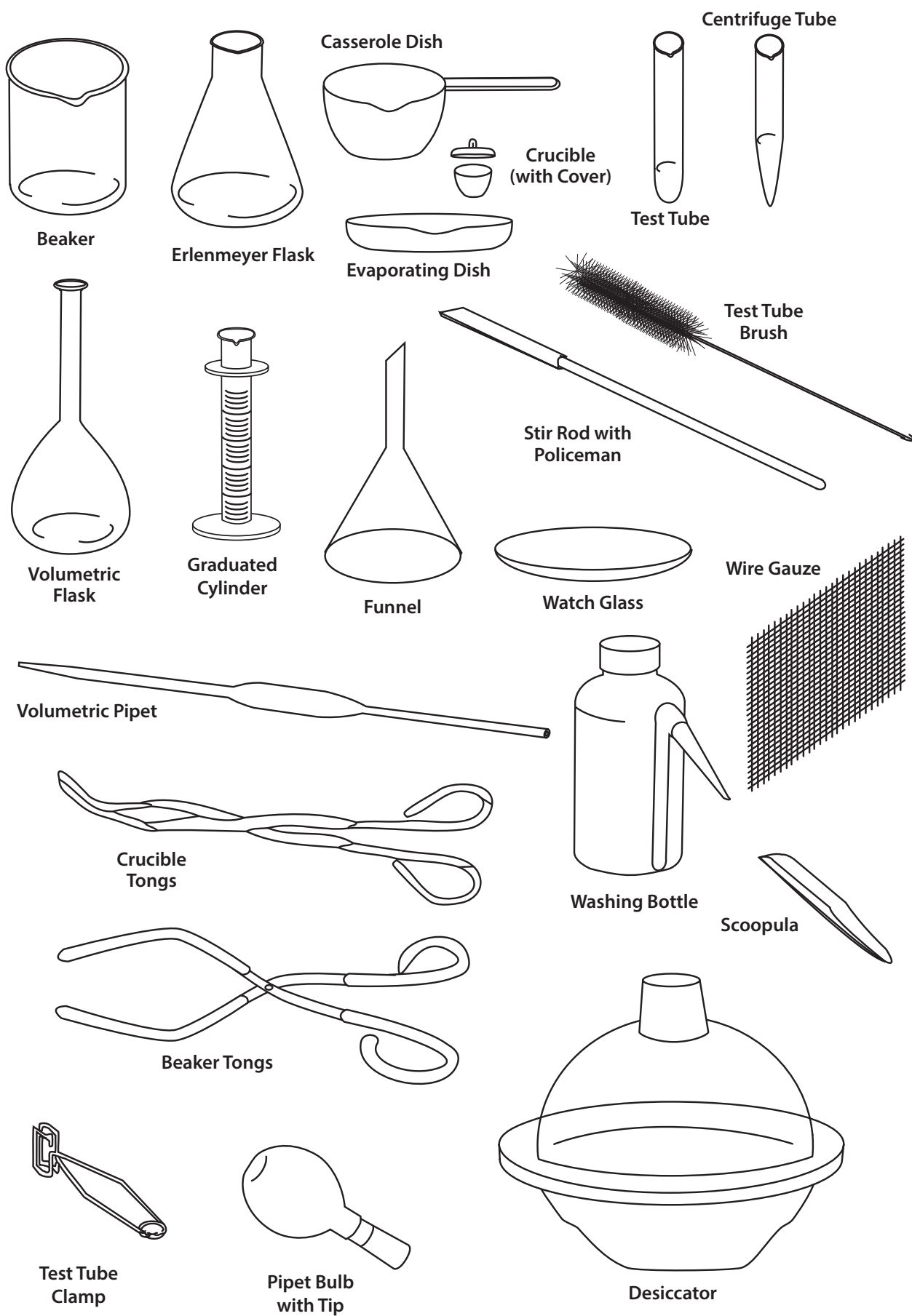

# Locker Inventory

**Procedure for beginning of quarter locker check-in:**

1. Count the numbers of items currently present in locker.
2. Place excess items from locker into the extra glassware box in the back of lab.
3. Return community supplies to the appropriate storage location.
4. Check out missing items from the following sources:
  - a) from the extra glassware box in the back of lab
  - b) from the Dispensary service window (1st floor, SLB 1060E)
5. Clean and dry all equipment.

**CHEMISTRY 2 LOCKER LIST**

Glassware			Porcelain		
# present	# total	Description	# present	# total	Description
	1	100 mL Beaker		1	150 mL Casserole Dish
	1	150 mL Beaker		1	Evaporating Dish
	1	250 mL Beaker		2	Crucible
	1	400 mL Beaker		2	Crucible Cover
	1	800 mL Beaker	<b>Plastic Ware</b>		
	2	50 mL Erlenmeyer Flask	# present	# total	Description
	2	250 or 500 mL Erlenmeyer Flask		1	250 mL Washing Bottle
	1	100 mm Watch Glass		1	Short Stem Funnel
	2	Glass Stir Rod		2	1 L Bottle, square
	10	Test Tubes (rounded end)		1	Desiccator
	6	Centrifuge Tubes (pointed end)		1	Plastic Test Tube Rack
	2	Thermometer, non-mercury	<b>Other</b>		
	2	25 mL Volumetric Flask	# present	# total	Description
	1	250 mL Volumetric Flask		1	Centrifuge Tube Brush (pointed)
	1	10 mL Graduated Cylinder		1	Test Tube Brush (round)
	1	25 mL Graduated Cylinder		1	Vial, Alkacid Test Paper
<b>Metal Equipment</b>				1	Sponge
# present	# total	Description		2	Rubber Policeman
	1	Wire Gauze Square			
	1	Scoopula			

**COMMUNITY SUPPLIES  
(not in student lockers)**

Lab Island Lockers	Wall Side Drawers
8" Extension Clamp	Beaker Tongs
Clamp Holder	Crucible Tongs
4" Support Ring	Test Tube Clamp
Overhead Storage Cabinet	Bunsen Burner
Pipet Bulb	Silicone Rubber Tubing
1 mL Pipet	Storage Cabinet
5 mL Pipet	20 mL Buret
10 mL Pipet	

## Locker Inventory

### Procedure for end of quarter locker check-out:

1. Clean and dry all equipment.
2. Count the numbers of items currently present in locker.
3. Place excess items from locker into the extra glassware box in the back of lab.
4. Return community supplies to the appropriate storage location.
5. Check out missing items from the following sources:
  - a) from the extra glassware box in the back of lab
  - b) from the Dispensary service window (1st floor, SLB 1060E)

### CHEMISTRY 2 LOCKER LIST

Glassware			Porcelain		
# present	# total	Description	# present	# total	Description
	1	100 mL Beaker		1	150 mL Casserole Dish
	1	150 mL Beaker		1	Evaporating Dish
	1	250 mL Beaker		2	Crucible
	1	400 mL Beaker		2	Crucible Cover
	1	800 mL Beaker	<b>Plastic Ware</b>		
	2	50 mL Erlenmeyer Flask	# present	# total	Description
	2	250 or 500 mL Erlenmeyer Flask		1	250 mL Washing Bottle
	1	100 mm Watch Glass		1	Short Stem Funnel
	2	Glass Stir Rod		2	1 L Bottle, square
	10	Test Tubes (rounded end)		1	Desiccator
	6	Centrifuge Tubes (pointed end)		1	Plastic Test Tube Rack
	2	Thermometer, non-mercury	<b>Other</b>		
	2	25 mL Volumetric Flask	# present	# total	Description
	1	250 mL Volumetric Flask		1	Centrifuge Tube Brush (pointed)
	1	10 mL Graduated Cylinder		1	Test Tube Brush (round)
	1	25 mL Graduated Cylinder		1	Vial, Alkacid Test Paper
<b>Metal Equipment</b>				1	Sponge
# present	# total	Description		2	Rubber Policeman
	1	Wire Gauze Square			
	1	Scoopula			

### COMMUNITY SUPPLIES (not in student lockers)

Lab Island Lockers	Wall Side Drawers
8" Extension Clamp	Beaker Tongs
Clamp Holder	Crucible Tongs
4" Support Ring	Test Tube Clamp
Overhead Storage Cabinet	Bunsen Burner
Pipet Bulb	Silicone Rubber Tubing
1 mL Pipet	Storage Cabinet
5 mL Pipet	20 mL Buret
10 mL Pipet	



## Periodic Table of the Elements

18 VIIIA 8A																																																																																											
1 IA 1A		2 IIA 2A		8 VIII 8										10 IB 1B		12 IIB 2B		17 VIIA 7A		18 VIIIA 8A																																																																							
1 <b>H</b> Hydrogen 1.008	3 <b>Li</b> Lithium 6.941	4 <b>Be</b> Beryllium 9.012	11 <b>Na</b> Sodium 22.990	12 <b>Mg</b> Magnesium 24.305	19 <b>K</b> Potassium 39.098	20 <b>Ca</b> Calcium 40.078	37 <b>Rb</b> Rubidium 84.468	55 <b>Cs</b> Cesium 132.905	87 <b>Fr</b> Francium 223.020	21 <b>Sc</b> Scandium 44.956	22 <b>Ti</b> Titanium 47.867	23 <b>V</b> Vanadium 50.942	24 <b>Cr</b> Chromium 51.996	25 <b>Mn</b> Manganese 54.938	26 <b>Fe</b> Iron 55.845	27 <b>Co</b> Cobalt 58.933	28 <b>Ni</b> Nickel 58.693	29 <b>Cu</b> Copper 63.546	30 <b>Zn</b> Zinc 65.38	37 <b>Rb</b> Rubidium 84.468	38 <b>Sr</b> Strontium 87.62	39 <b>Y</b> Yttrium 88.906	40 <b>Zr</b> Zirconium 91.224	41 <b>Nb</b> Niobium 92.906	42 <b>Mo</b> Molybdenum 95.95	43 <b>Tc</b> Technetium 98.907	44 <b>Ru</b> Ruthenium 101.07	45 <b>Rh</b> Rhodium 102.906	46 <b>Pd</b> Palladium 106.42	47 <b>Ag</b> Silver 107.868	48 <b>Cd</b> Cadmium 112.414	49 <b>In</b> Indium 114.818	50 <b>Sn</b> Tin 118.711	51 <b>Sb</b> Antimony 121.760	52 <b>Te</b> Tellurium 127.6	53 <b>I</b> Iodine 126.904	54 <b>Xe</b> Xenon 131.294	55 <b>Cs</b> Cesium 132.905	56 <b>Ba</b> Barium 137.328	63 <b>La</b> Lanthanum 138.905	64 <b>Ce</b> Cerium 140.116	65 <b>Pr</b> Praseodymium 140.908	66 <b>Nd</b> Neodymium 144.243	67 <b>Pm</b> Promethium 144.913	68 <b>Sm</b> Samarium 150.36	69 <b>Eu</b> Europium 151.964	70 <b>Gd</b> Gadolinium 157.25	71 <b>Tb</b> Terbium 158.925	72 <b>Dy</b> Dysprosium 162.500	73 <b>Ho</b> Holmium 164.930	74 <b>Er</b> Erbium 167.259	75 <b>Tm</b> Thulium 168.934	76 <b>Yb</b> Ytterbium 173.055	77 <b>Lu</b> Lutetium 174.967	81 <b>Tl</b> Thallium 204.383	82 <b>Pb</b> Lead 207.2	83 <b>Bi</b> Bismuth 208.980	84 <b>Po</b> Polonium [209]	85 <b>At</b> Astatine 209.987	86 <b>Rn</b> Radon 222.018	87 <b>Fr</b> Francium 223.020	88 <b>Ra</b> Radium 226.025	89-103 <b>Actinide Series</b>	91 <b>Pa</b> Protactinium 231.036	92 <b>U</b> Uranium 238.029	93 <b>Np</b> Neptunium 237.048	94 <b>Pu</b> Plutonium 244.064	95 <b>Am</b> Americium 243.061	96 <b>Cm</b> Curium 247.070	97 <b>Bk</b> Berkelium 247.070	98 <b>Cf</b> Californium 251.080	99 <b>Es</b> Einsteinium [254]	100 <b>Fm</b> Fermium 257.095	101 <b>Md</b> Mendelevium 258.1	102 <b>No</b> Nobelium 259.101	103 <b>Lr</b> Lawrencium [262]	104 <b>Rf</b> Rutherfordium [261]	105 <b>Db</b> Dubnium [262]	106 <b>Sg</b> Seaborgium [266]	107 <b>Bh</b> Bohrium [264]	108 <b>Hs</b> Hassium [269]	109 <b>Mt</b> Meitnerium [278]	110 <b>Ds</b> Darmstadtium [281]	111 <b>Rg</b> Roentgenium [280]	112 <b>Cn</b> Copernicium [285]	113 <b>Nh</b> Nihonium [286]	114 <b>Fl</b> Flerovium [289]	115 <b>Mc</b> Moscovium [289]	116 <b>Lv</b> Livermorium [293]	117 <b>Ts</b> Tennessine [294]	118 <b>Og</b> Oganesson [294]

Lanthanide Series

Actinide Series

